



Model: AR936

Operation Manual of Leeb Hardness Tester



SZ936-2009.10.16

special notice:

Turn off the unit before replacement
of battery or impact device!

Content

Maintenance and warranty policy

Maintenance:

1. Do not put the instrument under the following environment:
 - a. In risk of splash by water or highly intense dusty environment
 - b. Air of high content of salt or sulfurate
 - c. Air of other chemical substance
 - d. High humidity and temperature (above 60°C, 90%RH) or in sunlight
2. Don't disassemble the instrument or change the inner structure
3. Alcohol and diluent is erosive to the LCD, clean the housing with cloth of slight water.

Warranty policy

1. Refer to the terms in the warranty card
2. Any damage resulting from unauthorized dismantling of the unit, improper transport or storage in breach of the manual instruction as well as unauthorized amendment of guarantee card or lack of proof will lead to refusal of guarantee service.



Declaration:

- a. The battery used must be dealt with according to the local laws, rules and regulations.
- b. Our company reserves the right to upgrade and amend the specifications and design of the instrument and instructions, they are subject to change without further notification if any.



Other Items

1. Brief

- Features -----(04)
- Application and its range -----(04)
 - Application -----(04)
 - Application range -----(04)
- Model specifications -----(05)
- Operation condition -----(05)

2. Working principle and Diagram of the instrument

- Working principle -----(05)
- Diagram of the instrument -----(06)
 - Hardness tester -----(06)
 - Main unit -----(07)
 - D type impact device -----(07)
 - Irregular type impact device -----(08)

3. Technical features

4. Operation

- Before operation -----(9)
 - Requirements on the measured -----(9)
 - System setting -----(10)
 - Measuring condition setting -----(10)
- Measuring method -----(10)
 - Starting -----(10)
 - Load -----(10)
 - Placement -----(10)
 - Measuring -----(10)

- Pick up value -----(11)
- Turn off-----(11)

5.Special instruction

6.Details on operation

- Turn on ----- (12)
- Turn off -----(12)
- Measurement -----(12)
 - Main menu-----(13)
 - Measuring operation-----(13)
 - Buttons -----(13)
- Menu tree----- (14)
- Measuring condition setting -----(14)
 - Impact direction setting----- (15)
 - Average times setting----- (15)
 - Material setting----- (15)
 - Hardness setting----- (16)
 - Tolerance setting----- (16)
 - Hardness/intensity setting----- (16)
- Storage management -----(16)
 - Review from first group to the last -----(17)
 - Reviewing the selected----- (17)
 - Data transmission -----(17)
 - Deleting the selected----- (17)
 - Delete all -----(17)
 - Confirm of deletion----- (18)
- Data review----- (18)
- System review----- (19)
 - LCD brightness setting----- (19)

User notice

- 1、 After purchase of this unit, the user is expected to fill in the guarantee card with unit stamp, then deliver its copy along with the invoice copy to our customer service center, or ask the distributor to do so. Incomplete proof will lead to maintenance without guarantee.
- 2、 The instrument enjoys one year guarantee service since the purchase of the unit, in this period if there is any malfunction, against the guarantee card or invoice, contact our service center for free charge service. In case no guarantee card or invoice be presented our company will calculate the guarantee period since the date off factory.
- 3、 Beyond the guarantee period, the maintenance will be charged by our service department.
- 4、 The optional components like(irregular type impact device, enlonged cable, specialized software etc.) will be charged accordingly.
- 5、 Any damage resulting from unauthorized dismantle of the unit, improper transport or storage in breach of the manual instruction as well as unauthorized amendment of guarantee card or lack of proof will lead to refusal of guarantee service.
- 6、 Please follow the manual instruction to operate, if there is any malfunction, contact our company immediately.

Appendix 4

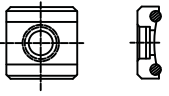
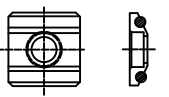
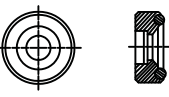
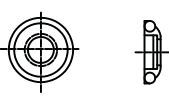
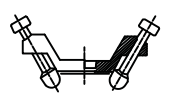
No	Model	Sketch of support ring	Remarks
1	Z10-15		for testing cylindrical outside surface R10-R15
2	Z14.5-30		out cylindrical surface R14.5-R30
3	Z25-50		out cylindrical surface R25-R50
4	HZ11-13		inner cylindrical surface R11-R13
5	HZ12.5-17		inner cylindrical surface R12.5-R17
6	HZ16.5-30		inner cylindrical surface R16.5-R30
7	K10-15		out cylindrical surface SR10-SR15
8	K14.5-30		For testing spherical outside surface SR14.5-SR30
9	HK11-13		for testing spherical inside surface SR11-SR13
10	HK12.5-17		inner cylindrical surface SR12.5-SR17
11	HK16.5-30		inner cylindrical surface SR16.5-SR30
12	UN		for testing cylindrical outside surface, radius adjustable R10-8

- Time/date setting------(20)
- System calibration -----(20)
- Program infomation -----(20)
- Backlight------(21)
- Automatical turn off -----(21)
- Battery replacement -----(21)
- Connection of data cable -----(21)

7. Trouble shooting

8. Maintenance

- Maintenance impact device ----- (22)
- Instrument maitenance -----(22)
- Instrument check------(22)
- Notice of storage and transport----- (22)

Appendix

- Appendix one -----(23)
- Apeendix two -----(24)
- Apeendix three -----(25)
- Apeendix four------(26)
- Notice for user -----(27)
- Maintenance and warranty policy----- (28)

1. Brief

1.1 Features

- Adopting Leeb hardness measuring principle, this unit can test the hardness of most metals.
- Large 160*80 lattice LCD display allows complete information and clear reading.
- All English display with menu indication makes the operation easy and convenient.
- Alternative white backlight display and USB plug facilitate the operation in darkness and communication with PC for data exchange and configuration.
- The main unit is matchable with 7 striking fittings, capable of identifying the striking type automatically, and requires no further calibration after replacement.
- The unit can store up to 500 groups of data (impact times 32~1), in which each group contains information of single value, average value, measuring date, impact direction, impact times, material and hardness unit.
- With presetting of up and low limits, the unit alarm automatically if reading is beyond the limits, which facilitates massive measurement.
- Battery volume icon on LCD indicates the battery power and calibratable with software.
- When using D/DC type impact device for steel material hardness testing, the reading can be displayed directly without consultation of the table.
- Equipped with PC program, this software supports transmission of the measuring results, storage management, statistical analyzing, print and massive parameters setting to ensure higher quality and management.
- Professional and nice outline, smart, portable and reliable performance makes the unit operable in rough environment, and immune from vibration, striking and electromagnetic interference.
- 4 AA alkaline batteries support continuous operation for more than 50 hrs. and automatic turn off function.
- Product Dimension: 150*80*38mm

1.2 Application and range

1.2.1 Application

- Tooling cavity
- Bearing and other workpiece.
- Pressure vessel, steam generator and its failure analysis.
- Heavy workpiece.
- Mounted mechanism and permanent assembly.
- Workpiece with small testing space.
- Original record of testing results required.
- Division of metal material warehouse.
- Quick test for many locations on large workpiece.

1.2.2 Measuring range

see appendix one and two.

Appendix 3

impact device		DC(D)/DL	D+15	C	G	E
impacting energy and mass of impact body		11mJ 5.5g/7.2g	11mJ 7.8g	2.7mJ 3.0g	90mJ 20.0g	11MJ 5.5g
ball hardness ball diameter ball material		1600HV 3mm carbonized tungsten	1600HV 3mm	1600HV 3mm	1600HV 5mm	5000HV 3mm 金钢石
Diameter of impact device length of impact device weight of impact device		20mm 86(147)/ 75mm 50g	20mm 162mm 80g	20mm 141mm 75g	30mm 254mm 250g	20mm 155mm 80g
max hardness of workpiece		940HV	940HV	1000HV	650HB	1200HV
Ra: average roughness of workpiece		1.6 μ m	1.6 μ m	0.4 μ m	6.3 μ m	1.6 μ m
min weight of workpiece direct measure requires solid support and intense coupling		>5kg 2~5kg 0.05 2kg	>5kg 2~5kg 0.05~2kg	>1.5kg 0.5~1.5kg 0.02~0.5kg	>15kg 5~15kg 0.5~5kg	>5kg 2~5kg 0.05~2kg
min thickness of workpiece intense coupling min depth of rigidified layer		5mm ≥0.8mm	5mm ≥0.8mm	1mm ≥0.2mm	10mm ≥1.2mm	5mm ≥0.8mm
size of ball impress						
hardness 300 hv hour	indentation diameter indentation depth	0.54mm 24 μ m	0.54mm 24 μ m	0.38mm 12 μ m	1.03mm 53 μ m	0.54mm 24 μ m
hardness 600 hv hour	impress diameter impress depth	0.54mm 17 μ m	0.54mm 17 μ m	0.32mm 8 μ m	0.90mm 41 μ m	0.54mm 17 μ m
hardness 800 hv hour	impress diameter impress depth	0.35mm 10 μ m	0.35mm 10 μ m	0.35mm 7 μ m	-- --	0.35mm 10 μ m
application range of impact device		DC type for hole or cylinder. DL type for long and narrow channel or hole D type for general pieces test	D+15 type for measuring in grooves or recessed surfaces	C type for measuring light and small piece and surface hardened layer	G type for measuring heavy and rough cast and forged pieces	E type for high hardness material

appendix two

No	Material	Leeb hardness HLD	Intension 0 b (MPa)
1	C	350~522	374~780
2	C	500~710	737~1670
3	Cr	500~730	707~1829
4	CrV	500~750	704~1980
5	CrNi	500~750	763~2007
6	CrMo	500~738	721~1875
7	CrNiMo	540~738	844~1933
8	CrMnSi	500~750	755~1993
9	SSST	630~800	1180~2652
10	SST	500~710	703~1676

1.3 Specifications:

Table 1

	No	Name	Number	Remark
Standard packing	1	main unit	1PCS	
	2	D type impact device	1PCS	
	3	Standard leeb hardness block	1PCS	
	4	A Nylon brush A	1PCS	
	5	Support ring	1PCS	
	6	AA alkaline battery	4PCS	
	7	Manual	1PCS	
	8	Alluminum box	1PCS	
	9	software CD	1PCS	
	10	USB cable	1PCS	
optional accessory	11	B Nylon brush B	1PCS	For G type impact device
	12	Irregular type impact device and support ring	1PCS	See appendix 3 and 4
	13	Leeb hardness testing method for metals.	1PCS	GB/717394-1998

1.4 Operating condition

environment temp: operating temp-20~+60°C ; storage temp: -30°C~+60°C

relative humidity<90%;

Do not use the instrument in strong vibration, magnetic field, erosive substance and high density powder and dust coditions.

2. Working principle and Diagram of the instrument

2.1 Working principle

An impact body with a spherical test tip made of tungsten carbide is propelled against the sample surface by a spring force and then rebounds back. At a distance of 1mm from the sample surface, the impact and rebound velocity of the impact body, when passing through the coil in its coiler holder, induces in the coil and electric voltage proportional to the velocities fo the magnet. Leeb hardness as the follo wing formula:

HL=1000VB/VA:

HI — leeb hardness

Vb — rebound velocity of the impact body

VA — impact velocity of the impact body

Voltage characteristic of output signal:

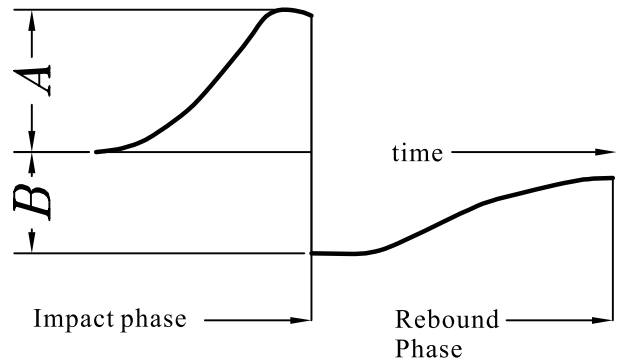

2.2 Diagram of the instrument

2.2.1 Hardness tester



Appendix Appendix one

material	hardness unit	impact device					
		D/DC	D+15	C	G	E	DL
steel and cast steel	HRC	17.9~68.5	19.3~67.9	20.0~69.5		22.4~70.7	20.6~68.2
	HRB	59.6~99.6			47.7~99.9		37.0~99.9
	HRA	59.1~85.8				61.7~88.0	
	HB	127~651	80~638	80~683	90~646	83~663	81~646
	HV	83~976	80~937	80~996		84~1042	80~950
	HS	32.2~99.5	33.3~99.3	31.8~102.1		35.8~102.6	30.6~96.8
steel	HB	143~650					
CWT、ST	HRC	20.4~67.1	19.8~68.2	20.7~68.2		22.6~70.2	
	HV	80~898	80~935	100~941		82~1009	
Stainless steel	HRB	46.5~101.7					
	HB	85~655					
	HV	85~802					
GC. IRON	HRC						
	HB	93~334			92~326		
Nc、IRON	HRC						
	HB	131~387			127~364		
c. alum	HB	19~164		23~210	32~168		
	HRB	23.8~84.6		22.7~85.0	23.8~85.5		
brass	HB	40~173					
	HRB	13.5~95.3					
bronze	HB	60~290					
copper	HB	45~315					

8. Maintenance

8.1 Impact device

- After operation for 1000~2000 times, clean impact device pipe and impact device tube with nylon brush. For cleaning the pipe, take out the impact device tube body by unscrewing the support ring, screw the nylon brush anticlockwise into the pipe until the bottom then pull out, repeat this five times, then re-install the impact device tube and support ring.
- After operation release the impact device tube.
- Forbid to use any lubricant for impact device tube..

8.2 Instrument maintenance

- When checking with Rockwell hardness block and finding the error over 2HRC, it is recommendable to replace the head or impact device resulting from ball wearing.
- In case that there is any malfunction of the instrument, the user shall not dismantle or replace any component of the instrument, please fill in the guarantee card and return the unit to our maintenance department.

9. Instrument checkup

The checkup period shall not be more than one year, the users can decide its regular checkup period at their convenience.

10. Storage and transport

- Keep the unit away from the vibration, high magnetic field and erosive substance, humid zone and dusty room in normal temperature.
- Keep the original package, the instrument can be transported on 3 level road.

2.2.2 Main unit

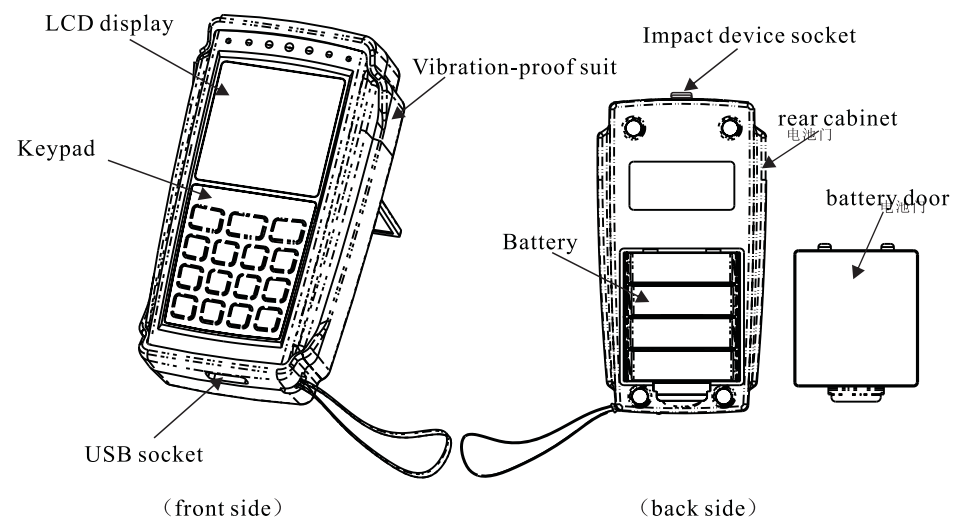

2.2.3 D type impact device

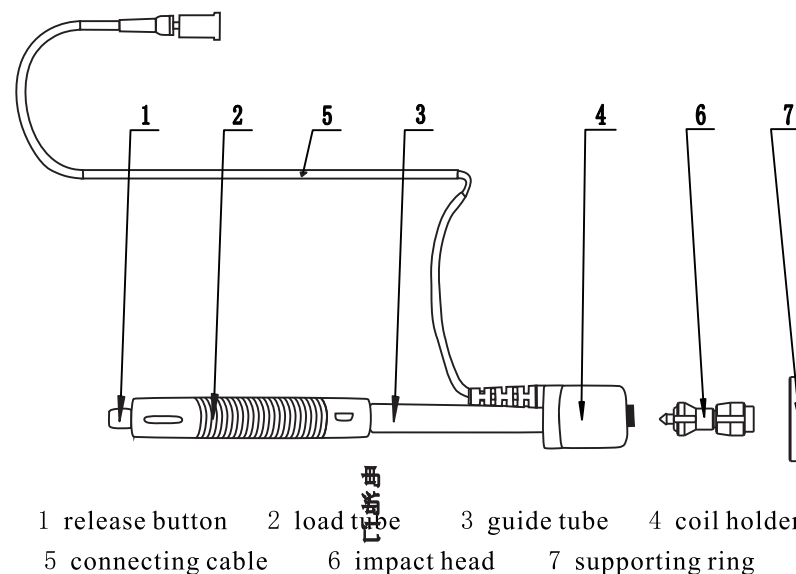

2.2.4 Irregular impact device

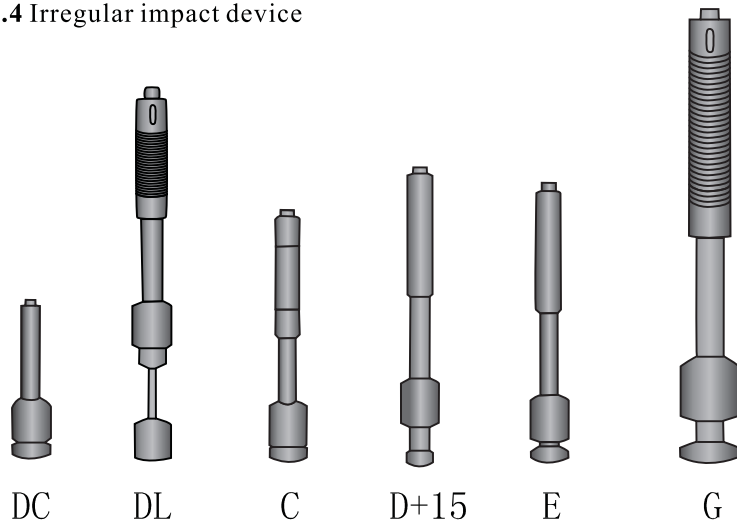

3. Technical features

- See table 2 for tolerance and reading repeatability

Table 2

No	impact device	hardness of the block	tolerance of the reading	reading repeatability
1	D	760±30HLD 530±40HLD	±6 HLD ±10 HLD	6 HLD 10 HLD
2	DC	760±30HLDC 530±40HLDC	±6 HLDC ±10 HLDC	6 HLD 10 HLD
3	DL	878±30HLDL 736±40HLDL	±12 HLDL	12 HLDL
4	D+15	766±30HLD+15 544±40HLD+15	±12 HLD+15	12 HLD+15
5	G	590±40HLG 500±40HLG	±12 HLG	12 HLG
6	E	725±30HLE 508±40HLE	±12 HLE	12 HLE
7	C	822±30HLC 590±40HLC	±12 HLC	12 HLC

- Measuring range: HLD (170~960) HLD
- Measuring direction: vertical down, side down, horizontal, side up and vertical down
- Material: steel & cast-steel, alloy tool steel, stainless steel, gray cast iron, nodular cast iron, cast aluminum alloy, copper-zinc alloy, copper-tin alloy, pure copper, and forged steel.

6.11 Backlight



The white backlight facilitates operation in darkness, pressing  button to turn on/off the light in main menu interface.

6.12 Auto turn off

- The function is to save the energy
- If no further operation within 5 min the instrument will turn off automatically

- The battery icon will be blank if there is low battery “”。

6.13 Battery replacement

After long time operation, the “” battery icon becomes faded, the more black part the more battery volume; after exhaustion of the battery, the battery icon shows “”, this means to replace the battery immediately.

Refer the following figure to install the battery:

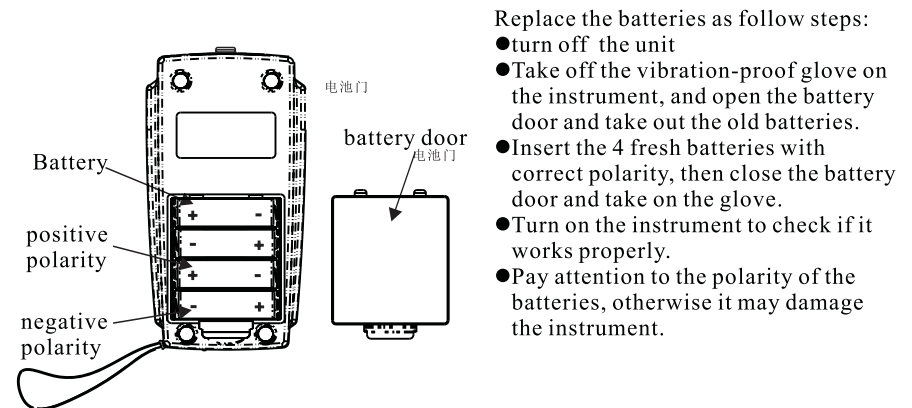

Replace the batteries as follow steps:

- turn off the unit
- Take off the vibration-proof glove on the instrument, and open the battery door and take out the old batteries.
- Insert the 4 fresh batteries with correct polarity, then close the battery door and take on the glove.
- Turn on the instrument to check if it works properly.
- Pay attention to the polarity of the batteries, otherwise it may damage the instrument.

6.14 Data transmission cable connection

Plug one end of the cable into the USB socket at the left of the host while the other end into PC's USB socket.

7. Trouble shooting

Problem	Analysis	Action
Fail to turn on	Exhaustion of battery	Replace battery
	Wrong polarity connection	Connect the battery in proper polarity
Blur reading	Low battery	Replace battery

6.8.2 Time / date setting

time / date setting

10/05/2005 11:02

Current time/date displays on the LCD in format of month/date/year hr/min.

Press number buttons to input the number, the cursor will move from left to right repeatedly.

Press “ENTER” button to complete the setting.

Press “ESC” button to cancel the change.

6.9 System calibration

First operation, or use after a long time, the instrument and the impact device must be calibrated with the provided leeb hardness block. When several impact devices are provided with main unit, every impact device only need one calibration, and no need to re-calibrate when replacing impact device.

Press menu to enter into system calibration submenu.

system calibration

0times
(testing 5 times)

Setting the impact direction as [↓] .

With leeb hardness block, test 5 locatons in direction of vertical downward.

Software Calibration

Average = 780
Real Value= 780

After testing, averages display.

Press [▲] [▼] to input real value.

Press “ENTER” button to complete the calibration.

Press “ESC” button to exit the operation.

Calibraton range: ± 15hl.

6.10 software info

press menu to enter into main menu

Storage Manager
System Configuration
system calibration

Press [▲] [▼] to move the cursor to software Info.

Press “ENTER” button to enter into software info.

version No:AR936 B01
indentifier AR963BETA01
SN: 93600000

This interface shows the info about the instrument and the plug-in software

The software version no and plug-in software indentifier is subject to change without further notification.

- Hardness unit: (HL)、(HB)、(HRB)、(HRC)、(HRA)、(HV)、(HS)
- Display: LCD, 160*80 lattice LCD display
- Data storage: up to 500 groups (impact times:32~1)
- Operating voltage: 6V (4*1.5V AA batteries)
- Continuous operating time: 50hrs without backlight.

4. Instrument operation:

4.1 Before operation

4.1.1 Requirements of the measured.

The surface of the measured must meet the requirements contained in table 3.

- The surface of the measured must be no more than 120℃.
- The roughness can not be too high, otherwise errors may be occurred. The measured surface must be polished and blare as smooth and flat as possible without oil smear.
- Weight of the measured: for the measured of more than 5kg, there is no need to support; for that of 2~5kg or of thin walls construction, a support must be applied while operating to avoid distortion, warpage and movement; for middle scale workpiece, it must be placed in balance on a flat and concrete surface without any vibration or moving.
- Curve surface workpiece: the testing surface should be as flat. The small supporting ring or irregular type supporting ring shall be used for testing the workpiece which has its curvature radius less than 30mm(for D, DC, D+15, C, E and DL type impact device) and bigger than 50mm(G type impact device).

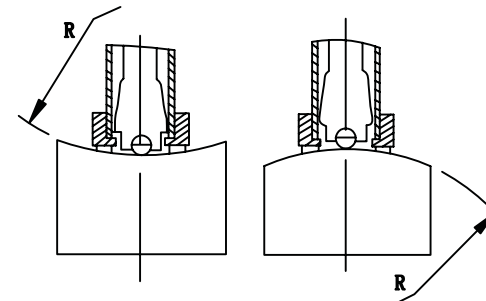

- The workpiece must be of enough thickness, for the minimum thickness please see the appendix table 3.
- For the workpiece of rigid surface, the surface must comply with the requirements prescribed in the appendix table 3.
- Coupling: for the light workpiece, it must be coupled with the solid supporting body, the two coupling surface must be flat and smooth without too much coupling agent applied. The testing direction must be vertical to the coupling surface. For the workpiece of large area, long stem shape, or crook shape, even its weight and thichness are enough, it is still possible to find the distortion and unbalance which

lead to incorrect measuring, so reinforcing or supporting at the back of the workpiece is necessary.

4.1.2 Instrument system setting: see 6.8 for details.

4.1.3 Measuring condition setting: see 6.5 for details.

4.2 Measuring method:

- Calibrate the unit with the provided hardness block before operation, and its tolerance and repeatability shall be in line with the table 2.

Note:

test the block in direction of vertical down for 5 times with the demarcated Leeb tester, and take the arithmetic average as the hardness value of the block. If the value is beyond the limit, use system calibration function to calibrate the unit.

4.2.1 Starting

- Plug the impact head in the socket at the middle of the unit.
- Press [] button to turn on the unit.

4.2.2 Loading(figure 1)

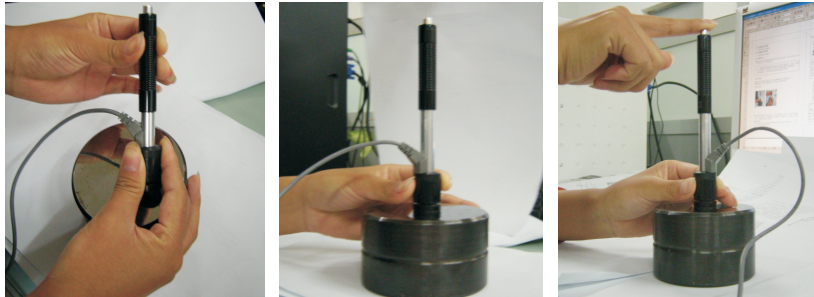

(figure 1)

(figure 2)

(figure 3)

- Push down the load tube to lock the impact body; for DC type impact device, adsorb the load stem on the surface of the workpiece; for DC impact device, insert the stem until stop for loading process.

4.2.3 Placement (figure2)

Clamp the striking support ring against the the surface of the workpiece in the selected direction vertically.



4.2.4 Measurement(figure3)

- Press the release button at the top of the impact device to measure while the workpiece, impact device and operator must stand steadily and the impact force should be in line with the axis of impact device.
- Normally test 5 times for each location of the workpiece. The max difference between these results should not be within $\pm 15HL$

6.8 System configuration



Press menu to enter into main menu

measuring
condition setting
storage manager
system configuration

Press [] [] to point the cursor to the System configuration

Press “ENTER” button to enter into the menu.

auto storage: off
eliminate the big error: off
auto data transmission: off
button sound: on
alarming sound: on
LCD brightness setting
time/date setting

Press [] [] to move the cursor to the desired.

Press “ENTER” button to change or enter into the change interface.

Press “ESC” button to exit



[Auto storage] [Eliminate the big error]
[Auto data transmission]

[Button sound] [Alarming sound] can be turned on/off by pressing the confirm button

- Auto storage: setting on will auto store the current group data after giving average reading.
- Eliminate the big error: setting on will auto eliminate the big error bounding the 3 σ regulations after the advance ending of complete measurement by pressing average button. If a data is eliminated, new data shall be supplemented to reach the times preset.
- Auto data transmission: setting on will output the current data through USB interface in text format after average reading is given.
- Button sound: setting on makes the buzzer beeps once at every button operation.
- Alarm sound: setting on makes the buzzer beeps once for a long time when the measurement is beyond the allowance limits.

6.8.1 LCD brightness setting

LCD brightness setting

press [] to increase the brightness
press [] to decrease the brightness

Press [] to increase the brightness

Press [] to decrease the brightness

Press “ENTER” button to complete the setting.

Press “ESC” button to cancel the change

6.6.5 Delete all

Delete All will delete all the data stored in memory.

6.6.6 Confirm delete

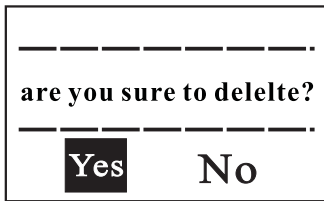

A confirm interface appears when delete the data stored.

Press [<] [>] to move the cursor to Yes and press "ENTER" button to delete the data.

Press [<] [>] move the cursor to No and press "ENTER" button to cancel the delete. Regardless the cursor position.

Press "ESC" button also lead to delete cancellation.

6.7 Data review

No. 001	12/03	652HL
No. 002	12/03	587HL
No. 003	12/03	820HL
No. 004	12/03	693HL
No. 005	12/03	783HL
No. 006	12/03	782HL
No. 007	12/03	579HL
No. 008	12/03	687HL

Every LCD page displays up to 8 groups of numbers, date and averages

Press [▲] [▼] to page up/down

Press "ESC" button to exit review

Press "ENTER" button to call cursor for further review.

No. 001	12/03	514HL
No. 002	12/03	785HL
No. 003	12/03	516HL
No. 004	12/03	789HL
No. 005	12/03	570HL
No. 006	12/03	852HL
No. 007	12/03	523HL
No. 008	12/03	796HL

Press [▲] [▼] to select the group displayed.

Press "ESC" button to exit review

Press "ENTER" button to call cursor for further review

Number 001	12/03/02
average=	514HL
D ↓	05 times
steel and cast steel	

Press [▲] [▼] to page up/down and review the averages, measuring conditions and single readings.

511	513	516
514	515	
Max: 516	Min: 511	

- The magnetism of the workpiece shall not be more than 15 gauss.
- Any distance between impresses and the distance between the center and the edge of the workpiece shall be in line with the regulation of table 3.
- For specific material, a comparison test must be performed to get a conversion map if you want to change the Leeb reading into other hardness value. This method is that using properly calibrated Leeb tester and the desired tester to test on the same workpiece at 3 locations nearby the target location and get 5 groups of the Leeb readings. Then take the average of these readings and these from another tester to make a conversion curve which at least must involve 3 pairs of sampling readings.

table 3

impact device	distance between center of the 2 impress	the distance between the center and edge of workpiece
	≥	≥
D、DC	3	5
DL	3	5
D+15	3	5
G	4	8
E	3	5
C	2	4

4.2.5 Read the value

- Take the average of readings from many valid testing locations as a Leeb hardness data.
- Before the Leeb hardness signal HL is the hardness reading. After that is the type of striking fitting type. For example, 780HLD means the tested hardness is 780 with type D impact device.
- For conversion from Leeb reading, a corresponding hardness signal shall be placed after the reading, for example, 420HVHLD means the Vicker reading is 420 with the type D impact device.

Note: The different impact device will have the different hl value reading, for example:

4.2.6 Turn off

press  button to turn off.

5. Special instruction:

- Replacement of battery impact device must be performed after turn off the unit, otherwise, the impact device can not be identified and might damage the unit.

- Normally, the reading cannot be stored if the impact times is less than the preset value. If you want to store the current reading, press the Average button to end the measurement and store the value.
- This performance of advance end of measurement by pressing Average button disable the functions of automatical storage and automatical transmission in the system munu.
- Only D type and DC type impact device enable the intension testing function, if other impact devices are used the hardness/intension settings cannot be changed. In case that if chage the setting as Intension with D/DC impact devices, then change the impact devices with others, the Hardness/Intension setting will be changed into Hardness automatically.
- If the setting is Intension, the hardness unit reset cannot be performed.
- Not all the material hardness can be converted into others, if the material is changed the tester will be restored into Leeb hardness unit automatically. So material setting msut be done before the hardness unit setting in process of condition setting.

6. Details of instrument operation

6.1 turn on: press [] to turn on as shown below:

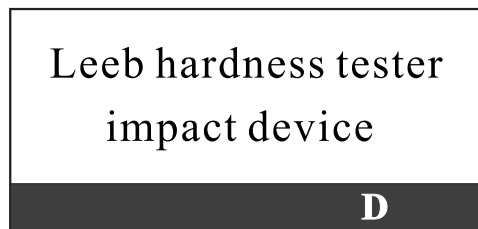

The instrument will check the impact device and show on the LCD, check if the display is right or not, then the unit enters into the main menu display.



6.2 In any case, press [] again to turn off the unit.

6.3 Measurement

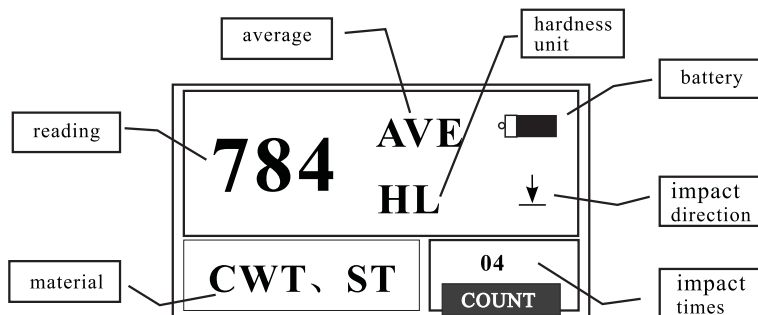
After turn on, the unit enters into the main menu as shown below:



review from the first group
 review form the last group
 review from the selected group
 data transmission
 delete the selected group
 delete all

Press the [] [] to move the cursor to the desired function
 Press "ENTER" button to confirm the choice.

6.6.1 Review from the first group/review from the last group

The former displays the data stored from the first group

The later displays the data stored fromt the last group

6.6.2 Review from the selected group

Select the start group from

001 to 010

001

- Review From the Selected Group will display the start group interface
- Press number buttons to input the number
- Press "ENTER" button to confirm the choice
- Press "ESC" button to cancel the change

6.6.3 Data transmission

Data Transmission will transmit the data in text from USB interface.

6.6.4 Delete the selected group

selectable group from

(001 to 017)

001 To 001

- Delete Selected Group will show the the interface of the selected group to be deleted
- Press the number button to input the number
- Press "ENTER" button to confirm the choice
- Press "ESC" button to cancel the change

Note:

1. If the group number is beyond the existed, all the existed groups will be deleted
2. There is no diffrence to input the first group number or final group number, ex, delete 1 to 5 equals delete 5 to 1
3. After deletion, the number of the stored group will be re-numbered
4. In deleting, especially for single group delete, for re-number the existing stored data, more 30 seconds is required, the instrument shall not be turned off to avoid messing up the data.

mild steel
high carbon steel
chrome steel

Press the [▲][▼] to move the cursor to the desired material
Press “ENTER” button to confirm the choice
Press “ESC” button to cancel the change

6.5.4 Hardness unit setting

current material
hardness unit

HL HV HB HRC
HS HRB HRA

Press [◀][▶] or [▲][▼] to move the cursor to the desired unit
Press “ENTER” button to confirm the choice
Press “ESC” button to cancel the change

Note:

1. Only the hardness unit available for convert with suitable impact device and material, for others this cannot be displayed.
2. Select material before hardness unit setting
3. After material setting, the hardness unit will be restored to HL automatically.

6.5.5 Tolerance limit setting

tolerance limit

low limit top limit
0200 0890

Press the Number button to input the number and the cursor will move repeatedly from left to right.
Press confirm to confirm the choice
Press Esc to cancel the change

Note:

1. If the setting is beyond the range, the instrument will alert you to reset.
2. If the low limit is bigger than the top limit, the instrument will reverse the setting.

6.5.6 Hardness/intension setting

material
hardness unit
tolerance limit
hardness/
intension: hardness

Press Confirm to select hardness/intension, the cursor shifts between the hardness and intension
Note: 1. only D/DC impact device are capable of intension measurement, for the others this choice is Hardness only.

6.6 Storage manage

Press the Menu to enter into main menu

measuring
condition setting
storage manage

Press [▲][▼] to move the cursor to Storage manage
Press “ENTER” button to enter into storage manage menu.
If there is no data stored, “NO DATA” shows.

6.3.1 Main menu instruction

Battery: shows the residual battery volume.

Impact direction: current direction

Average: when the preset impact times is reached, the average value shows.

Hardness unit: current unit

Reading: current single testing reading(without average alert), current average(with average alert).

↑ denotes value above convertable or measure range, ↓ denotes value below the convertable or measure range.

Material: current material setting.

Impact times: shows the impact times done with preset via Times button.

Times gives the info of the impact times and Single review gives the single readings with is times of a single reading.

6.3.2 Measuring operation

At this interface, each testing will be displayed, and the impact times added with 1, if the reading is beyond the tolerance, the buzzer gives a long beep; when preset times is reached the buzzer 2 short beeps, then the average shows after 2 seconds with the buzzer gives a short beep.

6.3.3 Button operation

- Press “STORE” button to store the current group reading, after the average is given. The data can only be store once.
- Press “DEL” button to delete the last single reading, before the confirmation of the following dialogue:

are you sure to delete?
yes no

By pressing the [◀][▶] button to move the cursor to Yes and click the Confirm button to confirm the delete of last single reading.
By pressing the [◀][▶] button to No and click the “ENTER” button to cancel the delete.
Regardless the cursor position, pressing the “ESC” button can also cancel the delete operation.

- Press[▲][▼] button to review the single readings, and press the Esc to restore the average or last reading display, press the [▲] or [▼] can review the info in order.
- Press “AVE” button to end the measurement advancely before the preset impact times and shows the average.
- Press[☀]to turn on / off the backlight(this functions only in the main menu interface)
- Press “MENU” button to enter into main menu
- Quick set button
- Press the “DIR” button to set the direction.
- Press the “TIMES” button to change the impact times set, first press will display the current the times set, each press add 1 until 32, then go back to the 1.

- Press the “HARDNESS” button to set the hardness unit, each press change the unit of the hardness, if the current set is intension it will go as Leeb hardness.
- Press “MAT’L” button will change the material seting, each press will cycle the materials preset in the instrument, and put the hardness as Leeb unit. So it is necessary to set material before hardness set.

Note: The so called conversion means that based on the massive tests for Leeb hardness and other hardness, a corresponding map is set up, and adopting this map the tester calculates and converts the Leeb hardness into other units.

6.4 Menu tree

All the instrument parameters's configuration and added functions can be performed with menu optertion, press the Menu button to enter into the main menu interface.

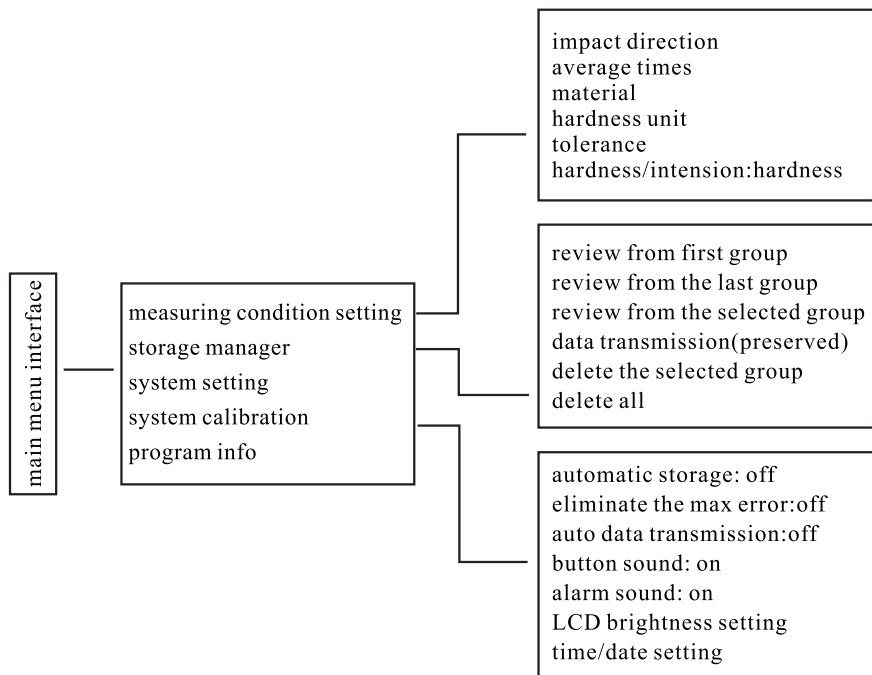

6.5 measuring condition setting

Press Menu button to enter into main menu interface.

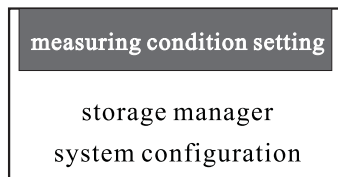

- Press “ENTER” button to enter into measuring condition setting menu.
- Press [▼] to review downward.
- Press [▲] to review upward.

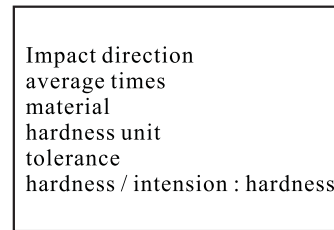

Press [▲][▼] button to move the cursor to the desired condition and press “ENTER” button to confirm choice.

Note: 1. If the hardness/intension is set as intension, hardness cannot be selected, the cursor jump over the Hardness unit choice.

2. Only D/DC impact device are available to intension measuring, when using other impact device, the cursor is not able to be moved to the Hardness/ Intension choice.

6.5.1 impact direction setting

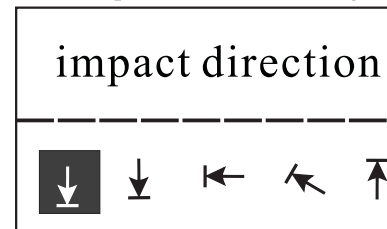

Press [<] [>] to move the cursor to the desired impact direction setting.

Press the “ENTER” button to confirm the choice.

Press the “ESC” button to cancel the change.

6.5.2 Average times setting

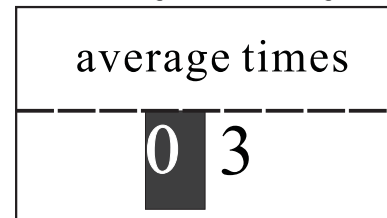

Available to select from 1 to 32.

Press the Number button to input the number and the cursor will move repeatedly from left to right.

Press “ENTER” button to complete the change.

Press “ESC” button to cancel the change.

6.5.3 Material setting

If the Hardness/Intension is set as hardness, the following materials will show on LCD steel & cast-steel, alloy tool steel, stainless steel, gray cast iron, nodular cast iron, cast aluminium alloy, copper-zinc alloy, copper-tin alloy, pure copper, forged steel

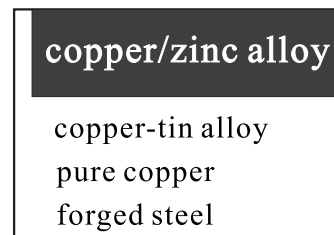

Press the [▲][▼] to move the cursor to the desired material.

Press the “ENTER” button to confirm the choice

Press the “ESC” button to cancel the change

Note: After material reset, the hardness unit will automatically restore itself to HL

2. Before selecting hardness unit, set the material.

If the Hardness/Intension is set as Intension, the following selectable material shows: Mild steel, high carbon steel, chrome steel, chrome/vanadium steel, chrome/nickle steel, chrome/molybdenum steel, chrome/nickle/molybdenum steel, chromansil,super high intension steel and stainless steel.