

Kett

Infrared Moisture Analyzer FD-800



Operating Manual

Thank you for purchasing this product.
Please read the operating manual carefully and use this product properly.

Safety Notes

Improper use of the infrared moisture tester in violation of the following safety notes may result in death, injury or damage to property due to fire, etc. Furthermore, the infrared moisture tester has high temperature components which can cause burns if proper safety guidelines are not followed.

■ Observe all safety guidelines



Carefully read and observe all safety notes included in this user's manual.

■ Do not use the unit if it appears to be malfunctioning

If you suspect a problem or malfunction in the unit, discontinue use and immediately have the unit inspected by certified Kett service personnel.

■ Meanings of Warning Indicators and Symbols

The following symbols are used in this operating manual and product to prevent accidents from occurring as a result of improper usage or handling. The meaning of each symbol is as described below.

 Warning	Failure to observe these items may lead to death or injury to the user.
 Caution	Failure to observe these items may lead to injury to the user or damage to property.
 Note	Items which the user should be aware of in order to use the unit safely.

Caution Symbols



Fire Hazard



Burn Hazard



Electric Shock Hazard

Stop Symbols



Prohibited



Do Not Disassemble



Do not Expose to Water

Symbols Requiring User Action







Required Action



Disconnect Plug from Electrical Outlet

 Warning  Fire Hazard  Electric Shock Hazard

-  Do not attempt to measure samples which may undergo dangerous chemical reactions when heated, as doing so may result in an explosion or release of toxic gas.
-  Do not place flammable materials near the infrared moisture tester. Some parts of the infrared moisture tester become extremely hot during operation and could lead to a fire if flammable materials are placed nearby.
-  Never use with any power source for which the product was not designed. Application of excessively high voltage may result in overheating, malfunction, or fire.
-  Do not attempt to disassemble, modify or rebuild the infrared moisture tester. Doing so may result in accident, electric shock, etc. If you believe the unit may be malfunctioning, take it to an authorized Kett service center for service.
-  Do not allow the unit to come in contact with water. The infrared moisture tester is not waterproof. Do not allow water or other liquids to get into the unit's enclosure as this may lead to electric shock or malfunction.

 Caution  Burn Hazard  Electric Shock Hazard

-  Do not touch the heat-dispersing component of the heater cover or sample dish with your bare hands, as doing so might result in burns. This infrared moisture tester is at high temperature during and immediately after making measurements. When touching the unit, only use the specified control knobs and accessories.

Contents

1. Precautions to be observed when taking measurements	6
2. Description of Features and Principles of Operation.....	8
■ Principles of Operation	8
■ Features.....	8
■ Applications (i.e., materials which can be measured)	8
3. Specifications	9
4. Names of Individual Parts and Components	10
4-1 Names of Parts of Main Unit.....	10
4-2 Parts and Accessories.....	11
5. Display and Control Panel	12
5-1 Display	12
5-2 Control Panel Operations	13
6. Assembly and Installation of Main Unit.....	14
7. Tips on how to ensure accurate measurements	17
8. How to Conduct Measurements	19
9. Specifying Measuring Conditions.....	23
9-1 Types of Settings	23
9-2 Descriptions of Individual Measuring Condition Settings	23
9-2-1 Selecting the CONDITIONS (Measuring conditions storage area).....	24
9-2-2 Selecting the MODE (Measuring mode).....	25
9-2-3 TEMP (Drying temperature)	34
9-2-4 Bias.....	35
10. Menu Settings	36
10-1 Types of Menu Settings	36
10-2 Descriptions of Individual Menu Items.....	36
10-2-1 Selecting units (measurement standard and minimum display units)	37
10-2-2 Specifying the type and format of output.....	38
10-2-3 Specifying sample codes	41
10-2-4 Specifying an ID (device ID).....	42
10-2-5 Setting the date and time	43
10-2-6 CAL (Scale calibration).....	44
10-2-7 Specifying a password	46
10-2-8 Specifying the power settings	48

11. Error Messages	49
12. Concerning the radiation thermometer	51
12-1 Radiation thermometer	51
12-2 Emissivity.....	51
12-3 Radiation thermometer temperature measurement spot.....	53
12-4 Relationship of T1 and T2.....	53
12-5 Radiation Thermometer Calibration Kit	54
13. Predictive Measurements	55
13-1 A Description of Predictive Measuring.....	55
13-2 Procedure for Obtaining Predicted Measurements	57
13-2-1 Calculating the bias to be specified when operating in predictive measurement mode	57
13-2-2 Evaluating predicted measurements	59
13-2-3 Obtaining predicted measurements	60
14. Printing Output to a Printer (Option)	61
14-1 Sample Printer Output	61
14-2 Outputting Past Measurement Data	64
15. Computer Interface	65
15-1 RS-232C Interface Specifications	65
15-2 Setting Up and Transmitting Data.....	66
15-2-1 Connecting the RS-232C cable.....	66
15-2-2 FD-800 settings.....	66
15-2-3 Starting up the computer	66
15-3 Computer Output Format.....	67
16. Maintenance	69
16-1 Performing Maintenance	69
16-2 Replacing Fuses	70



1. Precautions to be observed when taking measurements

Be sure to follow proper procedures during operation



- When opening or closing the lid to the heater, always be sure to use the handle.
- Be sure to put the wind shield, sample dish tray, handler, and sample dishes properly into place. (See “6. Assembly and Installation of Main Unit” on p. 14 for instructions.)



- Always be sure to use the provided handler to remove sample dishes.



- When removing a sample dish, do not allow your hands to come into contact with the heater or any of the metal (aluminum) parts around the heater, as doing so could result in burns.
- The sample dish and area around the sample dish will be very hot immediately after performing a measurement. Be sure to place the sample dish in an appropriate place to allow it to cool.

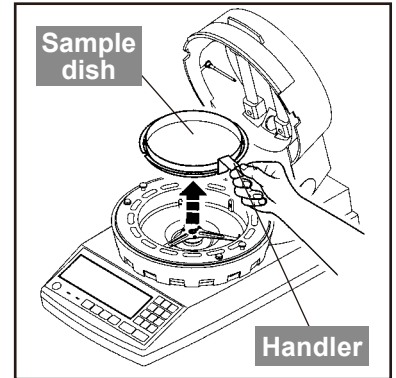
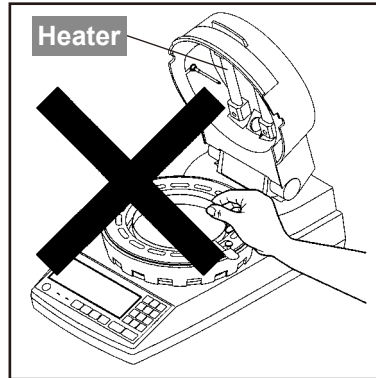
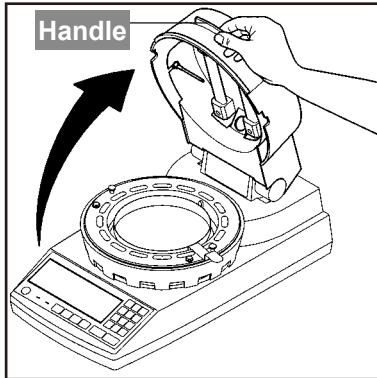

Areas to touch and areas subject to high temperatures



- While a measurement is being performed or immediately after a measurement has been performed, the areas marked in the accompanying diagrams as **HOT** will heat up to high temperatures. When handling the unit, always be sure to allow your hands to come into contact only with the designated areas.

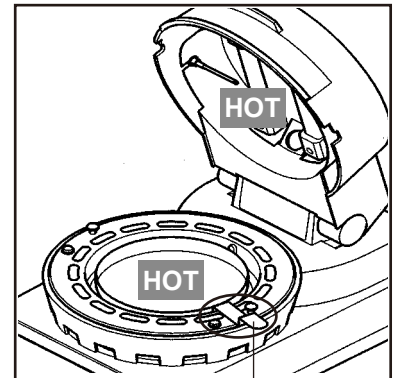
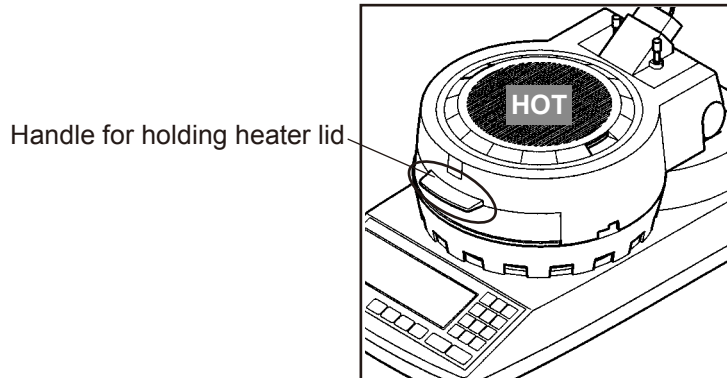

Place to grasp handler

Never perform measurements using hazardous materials



- Heating materials which would present a risk of explosion or combustion, or materials which could give off noxious fumes when heated, is extremely dangerous and this instrument should never be used with any such materials. The same also applies to the use of any materials which might cause hazardous chemical reactions to take place when heated.



- When heating materials that would first dry along the surface, and then allow the internal pressure to rise excessively, there is a danger that heating such materials could cause them to rupture. Such materials should never be measured, as doing so could be dangerous.



- If any materials being measured ignite, immediately remove the power plug from its socket and take appropriate measures to extinguish the fire.

Never place any easily flammable objects near the product



- The components of the infrared moisture tester can become very hot when measurements are being taken or immediately after measurements have been taken. The heat could cause objects or materials to catch fire if they were to come into contact with the unit, and no easily flammable objects or materials should be kept near the product.
- Never place any objects which might easily be damaged by heat near the unit, as doing so might result in deformation or damage to the objects in question.



- No objects should ever be placed upon the heater.
- If you see fire coming from the unit or notice smoke, an odd smell, or any other sign of abnormal functioning, remove the power plug from its socket, or take whatever other steps would be appropriate to deal with the problem.

Notes on using the control keys



- Never turn on the power to the unit while holding down any of the control keys.
- Never press any keys other than those directed or press two or more keys together at the same time unless directed to do so.
- When there is any danger that the unit might be damaged by lightning, remove the power plug from its socket.

Stopping operation

- The **Start/Stop** key can be pressed at any time during operation to halt operation. If you suspect for any reason that the product is not operating properly or that there is any sort of danger, immediately press the **Start/Stop** key to halt operation.

Setup and storage



- Avoid using or storing the unit in a location where it would be exposed to excessively high or low temperatures, high levels of humidity, direct sunlight, electromagnetic interference, corrosive gases, or large amounts of dust.
- Place the unit on a flat and stable surface where it will not be subjected to significant vibration during use.
- When moving the unit, never tilt it any more than necessary.
- Take care never to drop or bump the unit or otherwise allow it to be subjected to strong shocks or the application of excessive force.



- When removing the power cord or RS-232C interface cable, never pull on the cord or cable and instead hold the plug or cable connector when removing.
- When the unit is not to be used over an extended period of time, remove the power plug from its socket.

2. Description of Features and Principles of Operation

■ Principles of Operation

This unit determines the moisture and solid contents of samples by heating them using infrared illumination and measuring changes in mass due to evaporation. This is referred to as the loss on drying method and is the simplest method for determining moisture content and thus mandated by many public regulations related to measurement standards.

■ Features

- **Equipped with a radiation thermometer**

In addition to temperature measurement by a conventional thermistor (T1 measurement), it is equipped with a radiation thermometer that can directly measure the surface temperature of a sample. (T2 measurement*¹) This radiation thermometer permits drying of a sample in a short time with good reproducibility without burning the sample.

- **Equipped with a ten-key pad**

The ten-key pad is used to enter numbers and letters simplifying entry.

- **UniBloc sensor**

The core of the scale is formed by a single-unit aluminum UniBloc*² weight sensor which provides excellent responsiveness, temperature characteristics, and shock resistance. This UniBloc*¹ sensor ensures excellent reliability in moisture content measurements even over extended use.

- **New Auto Taring mechanism**

The FD-800 comes with an internal Auto Taring mechanism which makes it possible to perform reset correction while performing measurements, thus eliminating drift of the scale even when performing measurements over long periods of time and making it possible to obtain extremely reliable measurements.

- **Mid-infrared quartz heating lamp**

The FD-800 uses a mid-infrared quartz heating lamp (with a central wavelength of 2.6 μm). This heater provides excellent drying efficiency over a wide range of different types of sample, makes it difficult for differences to occur as a result of the colors of different samples, and eliminates the overheating of sample surfaces, thus making it possible to obtain ideal drying conditions.

What's more, this heating lamp also provides a long service life 5~10 times greater (20,000 to 30,000 hours*³) than older infrared or halogen lamps.

- **A wide selection of measuring modes**

The FD-800 provides a wide selection of measuring modes (automatic halting mode, timed halting mode, high-speed drying mode, low-speed drying mode, stepped drying mode, and predictive measuring mode) which makes it possible to perform measurements under the drying conditions most appropriate to the drying characteristics of the sample being measured.

- **The ability to store measuring conditions**

The FD-800 provides 100 measuring conditions storage areas which may be used to store sets of measuring conditions to be used for different types of materials, thus reducing the amount of time involved in specifying settings before performing measurements.

- **Data memory**

The FD-800 is able to store up to 100 sets of measurement data in memory, thus making it possible to output large batches of data all at one time.

- **Scale (and the radiation thermometer) can be calibrated**

Scales (and the radiation thermometer) can be calibrated. During calibration, output can be printed in response to the demand for GLP, GMP, ISO.

*¹ Patent pending.

*² UniBlock is a product name of the Shimadzu Corporation.

*³ Indicates average life of heater but does not guarantee actual life time.

■ Applications (i.e., materials which can be measured)

- Materials for which water is the only main component which evaporates as a result of heating
- Materials for which no dangerous chemical reactions or other changes occur as a result of heating
- * **Measurements can be performed using virtually any material meeting these conditions.**

3. Specifications

Measurement format	: Evaporation weight loss method (Heat drying and weight loss method)
Sample weight	: 0.5~120 g using selective weight sampling method
Minimum displayable units	: Moisture content (solids): 0.1% or 0.01% (selectable), Weight: 0.001 g
Measurable quantities	: Moisture content (wet base & dry base), weight, solid content
Measurement range	: 0-100% (wet base, solids) 0-500% (dry base)
Reproducibility (Standard deviation)* ¹	: Samples with a weight of 5 g or higher: 0.05% Samples with a weight of 10 g or higher: 0.02% ^{*1} When using standard samples and measuring conditions as determined by Kett Electric Laboratory.
Measurement modes	: Automatic halting mode Timed halting mode (with measurement times of 1~240 minutes or continuous measurement mode, with a maximum measurement time of 12 hours) High-speed drying mode (may be used with either automatic or timed halting mode) Low-speed drying mode (may be used with either automatic or timed halting mode) Stepped drying mode (performs drying in 5 steps) Predictive (comparative) measuring mode
Temperature range	: 30~180°C in 1-degree increments when using a thermistor (T1) 30~250°C in 1-degree increments when using a radiation thermometer (T2) ^{*2}
Display	: Backlit LCD display (137 x 43 mm)
External output	: RS-232C interface
Communications	: FD-800 Data Logger software FDL-02 (option)
Storage of measurement conditions	: 100 sets of measurement conditions
Data memory	: 100 sets of data
Environmental conditions	: Pollution degree 2, Altitude up to 2000 m
Temperature/ humidity operating range	: 5~40°C, maximum of 85% RH
Heat source	: Medium frequency infrared heater (200W x 2)
Temperature sensor	: Thermistor
Power supply,	: AC 100V~120V (50/60 Hz) 900W
Power consumption	: AC 220V~240V (50/60 Hz) 900W
Dimensions and weight	: 220 (W) x 415 (D) x 220 (H) mm, 5.4 kg
Sample dish	: SUS sample dish (Diameter: 130 mm; Depth 13 mm)
Accessories	: 2 sample dishes, 2 sample dish handlers, wind shield, sample dish tray, spoon & spatula set, 2 spare (T8A 250V) fuses, 2 packages of aluminum foil sheets (10 per package), Glass fiber sheets (10 sheets), operating manual
Options	: Printer set (includes a VZ-380 printer, a printer interface cable (VZC69), printer paper, and an AC adapter), printer paper (10 rolls), package of aluminum foil sheets (500 sheets), GF-210 radiation thermometer calibration kit (with a digital thermometer, heating standard sample) ^{*3} , FD-800 Data Logger software FDL-02 (RS-232C interface cable, USB-RS232C conversion cable), TQ-100 sample crusher, Deodorizing/windproof case (FW-100), Glass fiber sheets (100 sheets)

^{*1} When using standard sample and measuring condition as determined by Kett Electric Laboratory.

^{*2} If the T1 temperature exceeds 180°C during measurement, it may not reach the set temperature.

^{*3} It is used for radiation thermometer calibration. For details see the Users Manual that comes with the Radiation Thermometer Calibration Kit.

4. Names of Individual Parts and Components

4-1 Names of Parts of Main Unit

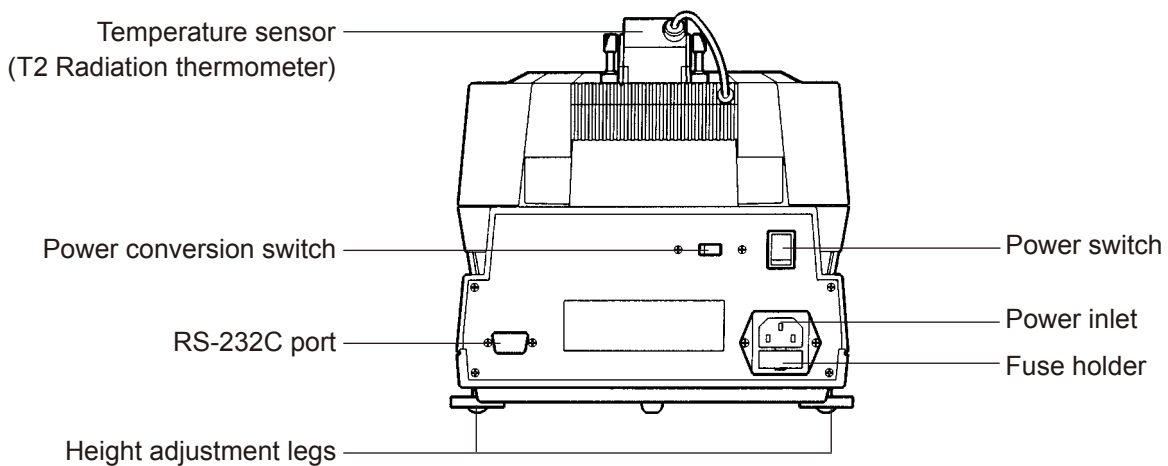
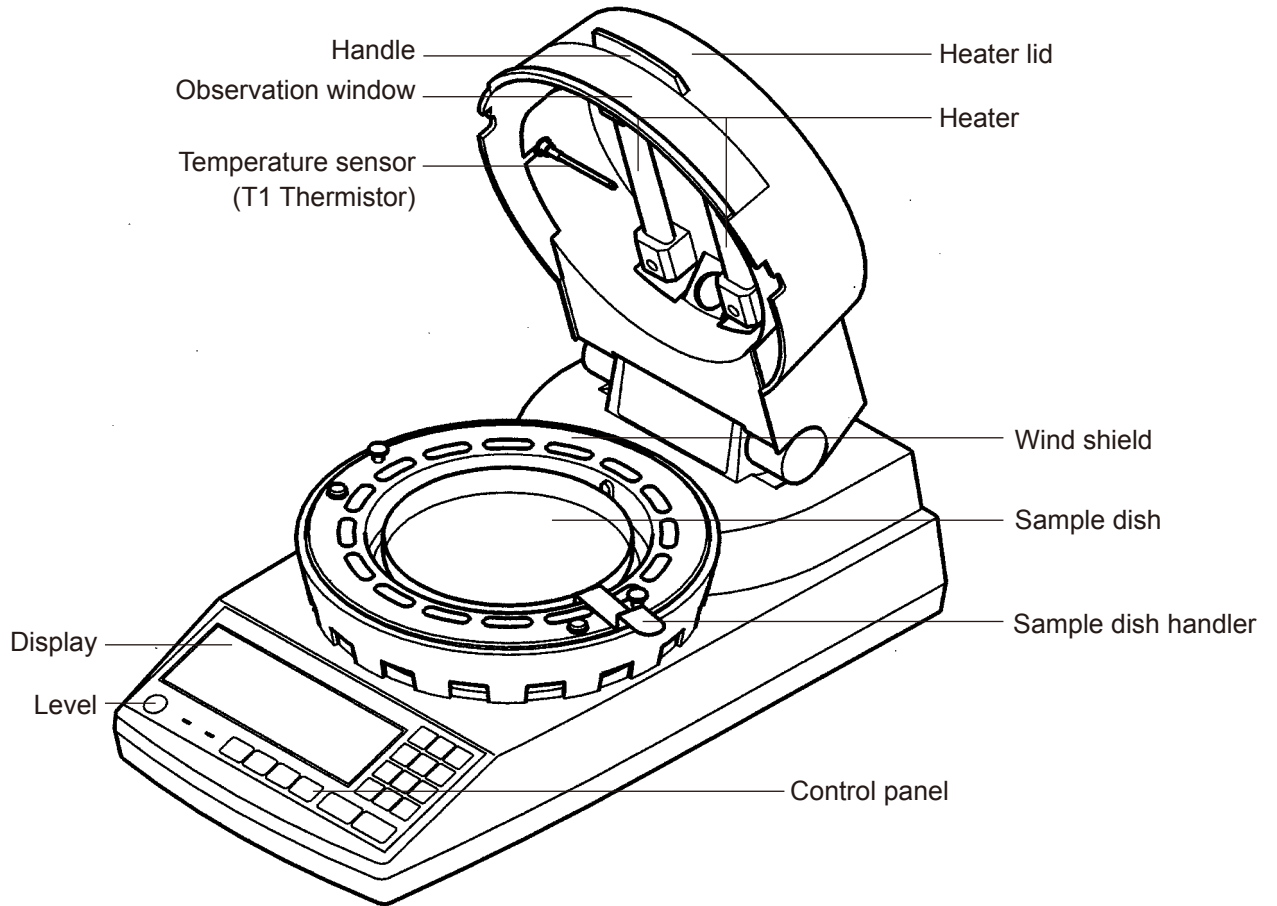

4-2 Parts and Accessories

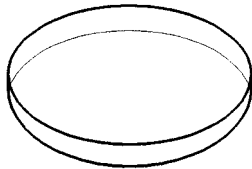

Sample dishes (2)

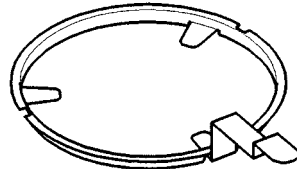

Sample dish handler (2)

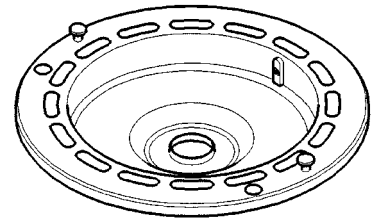

Wind shield

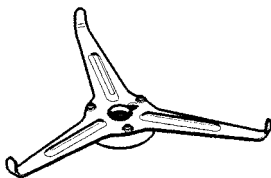

Sample dish tray

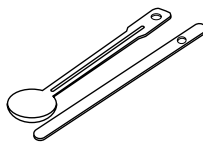

Spoon & spatula set

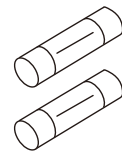

Spare (T8A 250V) fuses (2)

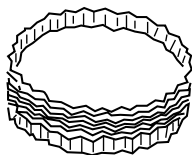

Packages of aluminum foil sheets (10 per package) (2)

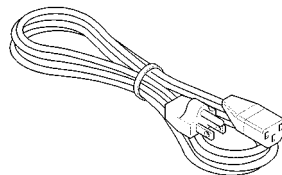

(Power cord)



(Three-prong plug adapter)

Note: The shape of the power plug varies in different countries. The actual accessory may be different from the one in this illustration.

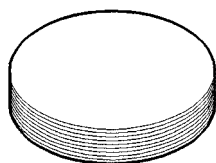

Glass fiber sheets (10 per package) (1)

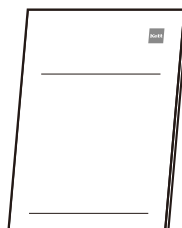

Operating manual

5. Display and Control Panel

5-1 Display

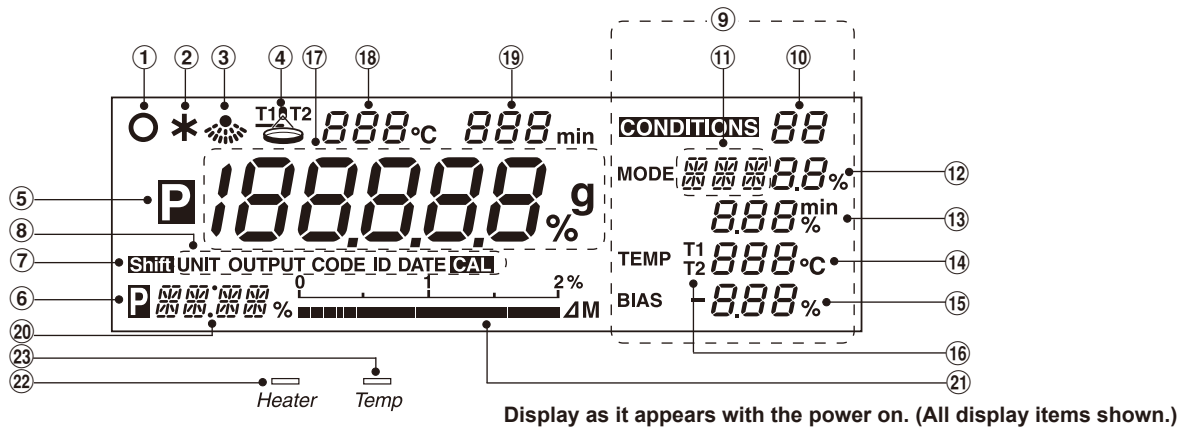









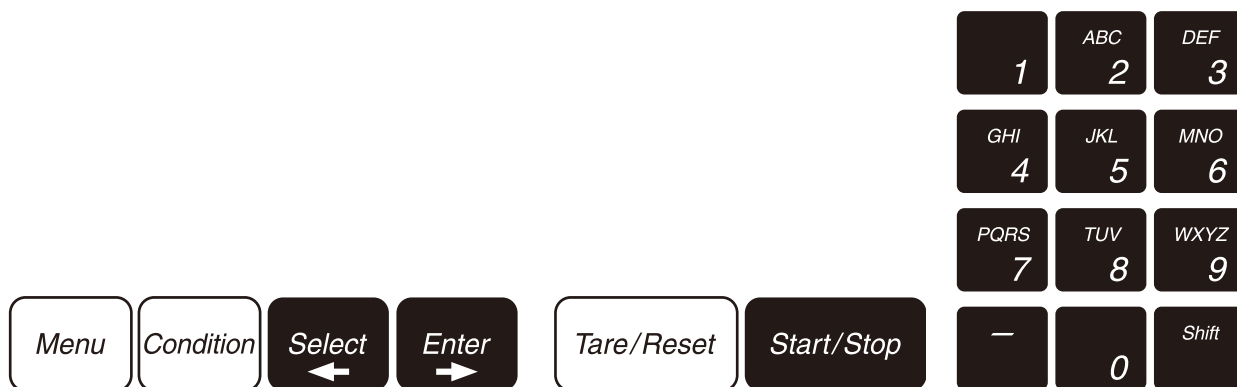

Item	Name	Description
①	Stability indicator	This indicator lights up when the internal scale is stable.
②	Measuring complete indicator	This indicator lights up when measuring has been completed.
③	Heater on indicator	This indicator flashes whenever the heater is turned on.
④	Thermometer selection mark	The temperature now indicated is either that provided by the thermistor (T1) or the radiation thermometer (T2).
⑤	Predictive measuring indicator	This indicator lights up when performing predictive measurements.
⑥	Predictive measuring indicator (Lights when performing comparative predictive measurement)	This indicator lights up when measuring has been completed after performing a comparative predictive measurement.
⑦	Shift mark	If the Shift key is pressed during alphabetic input, it is displayed (or not displayed). Alphabetic information can be entered with this mark illuminated.
⑧	Menu display	Used to display individual menu items in sequence each time the Select key is pressed after pressing the Menu key.
⑨	Measuring conditions display	Flashes to display individual items in sequence each time the Select key is pressed after pressing the Condition key. Values may be specified for a given item when it is flashing.
⑩	Measuring conditions storage area display*	Used to display the number of the currently selected measuring conditions storage area.
⑪	Measuring mode display*	Used to display the currently selected measuring mode.
⑫	Predictive measurement convergence conditions display*	Used to display the conditions for convergence of measured values when operating in predictive or comparative mode. When operating in high-speed drying mode, used to display the conditions required in order to maintain a high-speed drying temperature.
⑬	Halt conditions display*	Used to display the currently selected halt conditions. When the value is displayed as a percentage, it indicates that measuring will halt automatically, and when value is displayed in minutes, it indicates that measuring will halt when the specified amount of time is reached.
⑭	Drying temperature display*	Used to display the currently selected drying temperature.
⑮	Bias display*	Used to display the moisture (or solid) bias.
⑯	Temperature control switch indicator	Indicates whether the temperature control is performed by the thermistor (T1) or the radiation thermometer (T2).
⑰	Moisture/Solid/Weight display	When measuring weight (i.e., when in idling mode), used to display the weight in grams. When performing measurements, used to display the moisture content and solids content as percentages. When measuring weight, this display is also used to display 'oL' (i.e., overload) when the weight exceeds the maximum measurable weight and to display '-oL' (i.e., no overload) when the weight does not exceed the maximum measurable weight.
⑱	Temperature display	Used to display the temperature under the heater lid.
⑲	Measuring time display	Used to display the amount of elapsed time or remaining time during measuring.
⑳	Change in moisture (solid) content display	Used to display the change (ΔM) in moisture (or solid) content at 30-second intervals during measurement.
㉑	Change in moisture (solid) content scale display	Used to display the change (ΔM) in moisture (or solid) content in scalar format. The scale may display a maximum change of 2 percent/30 seconds.
㉒	Heater on LED	When the heater is on, it is red.
㉓	Temperature indicator LED	When the temperature is 39°C or less, it is yellow-green, and when it is 40°C or more, it is orange.

* Items marked with an asterisk display as flashing items.

5-2 Control Panel Operations

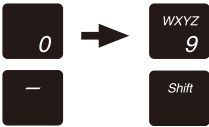
The control panel keys are used to perform the following operations.



Name	Operation
 START/STOP key	Used to start measuring or to abort a measuring operation. Also used to turn off the alarm which sounds to indicate that a measuring operation has been completed.
 TARE/RESET key	Used to deduct the tare weight. Also used to perform a reset after an error has occurred. Also used to return to display of weight after completion of measurement.
 ENTER key	Used to confirm currently selected settings. When further settings must be specified, pressing the ENTER key causes the next specified item to be displayed; when there are no further settings to be selected, the specified setting is confirmed and takes effect. And to enter numerals or letters, use it as an advance key.
 SELECT key	Used to select different settings or setting values.
 CONDITION key	Used to begin or end the specification of measuring conditions.
 MENU key	Used to begin or end the specification of menu settings.
 Ten-key/Shift key	<p>The    keys are used to enter numerals and letters.</p> <p>The  key is used to switch between numerals and letters.</p> <p>And it is used to switch between temperature indication (thermistor (T1) and radiation thermometer (T2)).</p>

6. Assembly and Installation of Main Unit

① Opening the package

Open the package and check to make sure all listed items are included.

② Installing the main unit

- Place the main unit on a flat, stable surface where it will not be subject to vibrations or exposed to drafts or breezes.
- Install the main unit so that it is at least 10cm from the wall both to the front and back and to the left and right. Make sure there is a space at least 30cm above the top of the heater cover.
- Do not use it in a closed installation environment. Depending on the sample, heating may produce hazardous substances. Install it in a location that can be adequately ventilated.

③ Removing the stopper from the sample dish panel

When using the unit for the first time after purchase, remove the scale stopper attached below the sample dish panel as indicated in the accompanying diagram.

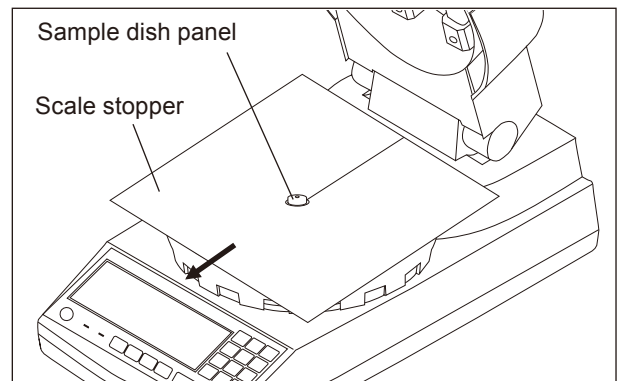

④ Checking the power settings

Check the power conversion switch located on the rear of the main unit to make sure that it is currently set to the proper voltage setting for your power source.

- * **Note that an error will occur if this switch is not set to a position matching the power source being used.**

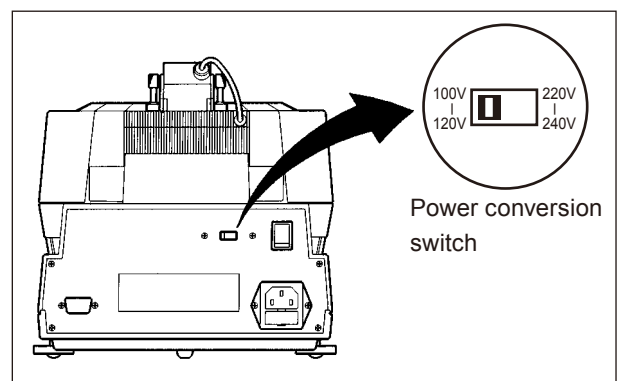

⑤ Ensuring that the unit is level

Turn the two height adjustment legs located at both sides of the lower rear of the unit to adjust until the level bubble falls within the red circle.

- * **The level is located to the left of the control panel. The tester is perfectly level if the bubble appears in the center of the red circle when viewed from directly above.**

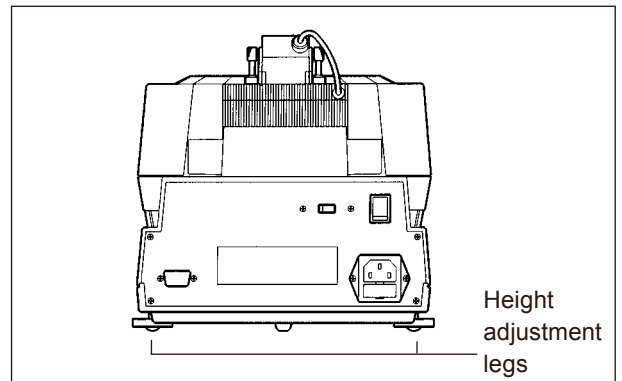
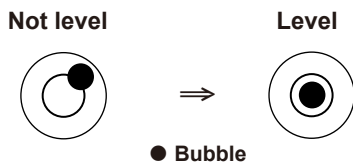

▲ Level is located to the left of the control panel.

⑥ Installing the wind shield

Open the lid of the heater, hold the wind shield by the knobs on the top, and place it on top of the sample dish panel so that the two round holes in the wind shield fit over the stays of the sample dish panel.

- * **Place the wind shield firmly into position so that it does not come into contact with the black projection located at the center of the main unit (sample dish panel).**

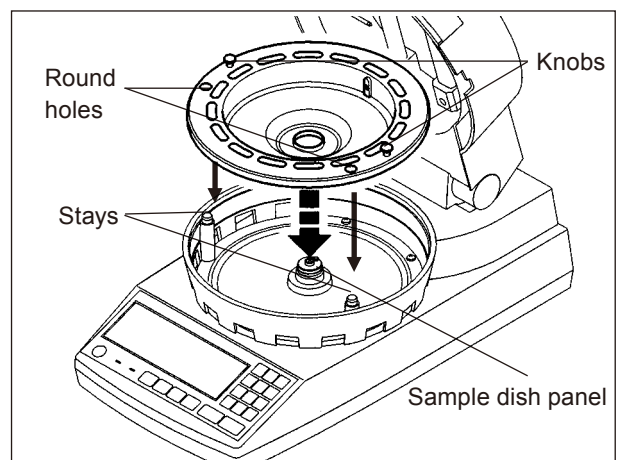

⑦ Attaching the sample dish tray

Place the sample dish tray gently into the sample dish panel at the center of the main unit, being sure when you do so that the round hole of the sample dish tray fit smoothly over the stay on the sample dish panel.

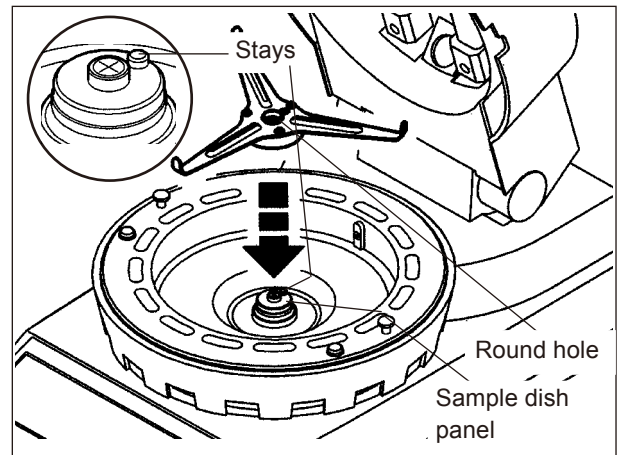

⑧ Attaching the sample dish handler

Next, attach the sample dish handler, being sure when you do so that the grooves of the handler fit smoothly over the projection located at the rear of the wind shield.

- * **While the sample dish handler is shown with the handle being placed to the right in the diagram shown here, the handle may be placed either to the left or right, and you should accordingly place the handle in the position you find easiest to use.**

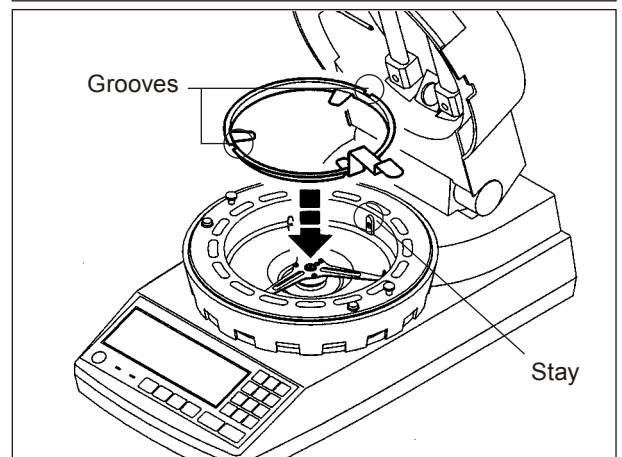

9 Placing the sample dish into the tester

Please place the sample dish gently down onto the sample dish tray.

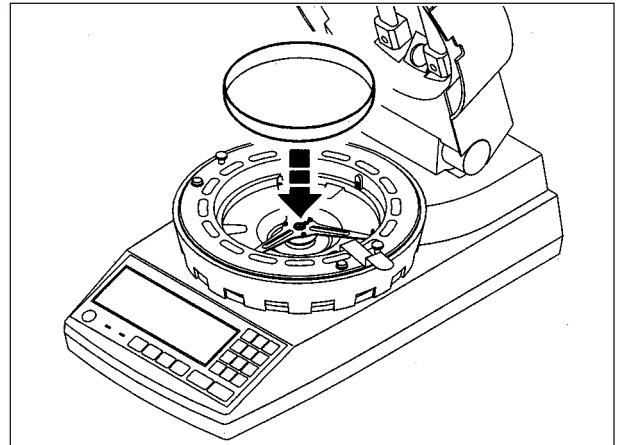

10 Close the heater lid

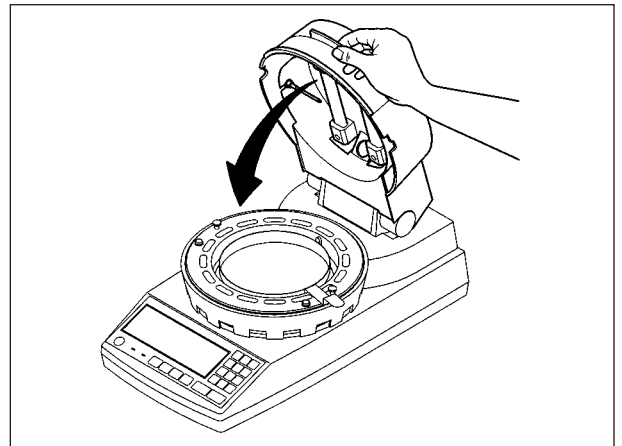

11 Connecting the power cord

Insert the female end of the power cord into the power inlet located at the rear of the unit. Then insert the power plug into the power outlet. Connect the plug to a power outlet in an easily accessed location so that it can be pulled out immediately if there are any problems with the infrared moisture tester. And be sure to always ground the main unit. If there is no grounding terminal on the power outlet, use a grounding adapter. The shape of the power plug varies in different countries. Use a power cord set suited to the shape of the plug that you actually use.

12 Connecting the printer (sold separately)

If you are using a printer, connect the printer using the provided printer interface cable. For instructions on how to use the printer, see the separately provided VZ-380 Printer User's Manual.

Assembly is now complete.

* **Some parts must be oriented in a fixed direction for assembly. Note that placing parts in the wrong direction may result in errors in operation or in erroneous readings being obtained, and that you should take care that all parts are put into place in their proper positions.**

7. Tips on how to ensure accurate measurements

● Points to remember when conducting multiple measurements in succession

1. Placing a sample onto a sample dish which is already warm may cause moisture from the sample to evaporate before measuring is begun and cause errors to occur in measurement. Always be sure to use a cool sample dish when performing a second or subsequent measurements.
You should also take care to allow an even amount of time to elapse between measurements, as errors in measurement may occur if the temperature of the internal scale of the unit does not remain at a constant level.
* **Two sample dishes and two sample dish handlers are included.**
2. Keep the measurement interval as regular as possible. If the temperature inside the measurement device is not constant, measurement errors may occur. When the temperature indicator LED changes from orange to yellow-green, set the criterion for starting a re-measurement as (39°C or less).
* **The indicated temperature at this time must be preset as the T1 display. Switching between T1 and T2 is done by pressing the  key.**
3. At the first measurement of the day or when the unit cools during an interval between measurements, discard the first measured value and use the second and subsequent measurements.

● Use of sample dishes and aluminum foil sheets

It is impossible to obtain accurate measurements if residue from the sample last measured remains on the sample dish. To avoid such problems, either wipe the sample dish clean of any dirt or soil (see “16. Maintenance” on p. 69 for further instructions) or use disposable aluminum foil sheets to protect against residues, soil, or dirt.

- * **Twenty disposable aluminum foil sheets are included with the unit.**

● Quantity and placement of powdered, particulate and viscous sample materials

The easier it is to heat the surface of a sample material, the easier it is for projecting portions of the material or for material at the top of a mound of material to become burnt. If the material is placed in a mound on the dish or if the material is not flat and evenly laid out, this is likely to happen, thus making it impossible to obtain accurate measurements.

Note that while the precision of measurement improves the more flatly and evenly samples are placed and the higher the amount of sample material used, the quantity of sample material used is too great if the surface becomes burned before lower layers are fully dried.

Always be sure to lay out samples flatly and evenly as indicated in the diagram below.



To make a measurement by radiation thermometer control (T2), be sure to do so with the specimen in the center of the (thermometer side) spot (specimen is embedded horizontally). Because the temperature of the sample tray (SUS) may be detected when part of the sample tray can be seen in the spot, a measurement error may occur.

- * **An SUS tray has a low emissivity, so its detection temperature is also low.**

When because of the state or shape of the sample, part of the sample tray is unavoidably visible inside the spot, (dry noodles, or fibrous materials, etc.), lay down the attached glass fiber sheet so that the sample tray cannot be seen to make the measurement. (see “12-3 Radiation thermometer temperature measurement spot” on p. 53 for further instructions)

● Measuring liquid samples

Virtually all liquid materials will coagulate after being dried, and when working with such materials they should be placed on the provided sheets of aluminum foil. Note that these aluminum foil sheets are water-permeable, thus making it possible to obtain wide and even placement and making them effective for use in shortening measuring times and obtaining accurate measurements. Depending on the sample in question, the use of the attached glass fiber sheet or of sand to speed up drying (Silica sand or ocean sand with a mesh of 20 or so) may be even more effective.

● Crushing samples consisting of large particles before measuring

If samples consisting of large particles are measured in their original condition it not only takes longer for drying to completed to the center, but also may result in problems such as the surface of the sample becoming burned, thus making it impossible to obtain accurate measurements. For this reason you should always crush samples to an appropriate size. The TQ-100 Sample Crusher (option) is excellent for this purpose.



TQ-100 Sample Crusher

● Remove sample residue and other dirt.

Depending on the sample, oil and volatile substances may stick to the temperature sensor and in the inside of the heater base when the sample is being dried. If the sample is in the form of a powder, under certain circumstances, the powder may accumulate on the upper side of the heater lid or in the space between the heater and lid. Such substances and powder can change the temperature around the sample and the air flow in the dryer section of the machine, resulting in an error in measured moisture.

A substantial error can especially arise if the upper side of the heater lid gets clogged with deposited material.

Frequently clean the apical end of the sensor, the inside of the heater base, the upper side of the heater lid, and the space between the heater and lid, and remove any dirt or sample residue.

- Wipe off the dirt with a dry, soft cloth.
- If dirt remains, wipe with a cloth wringed well after being soaked in water mixed with a little amount of neutral detergent. Then, dry after rinsing the cloth in running water, wringing it well, and wiping off the detergent.

Upper side of the heater lid

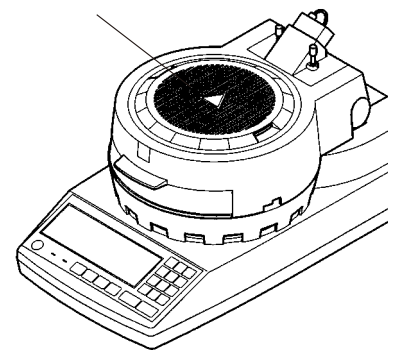

Space of the heater base

Apical end of the Temperature sensor

Inside of the heater base

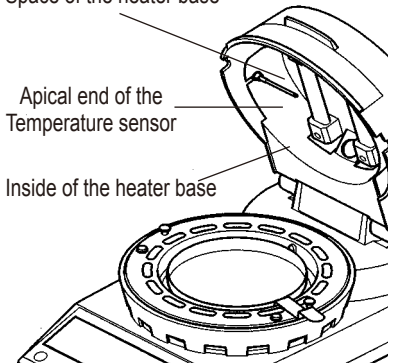

● Deodorizing windproof case

If the impact of exterior wind (from air-conditioners etc.) on the body is unavoidable or if the sample gives a bad odor during moisture content measurement, it is possible to lower these impacts by placing the device inside the deodorizing windproof case FW-100 (option).

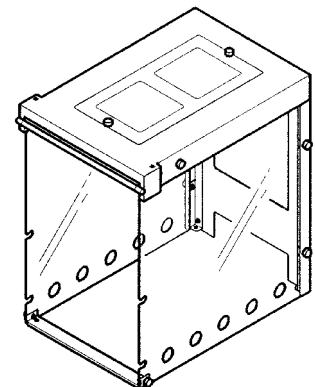





FW-100 Deodorizing Windproof Case

8. How to Conduct Measurements

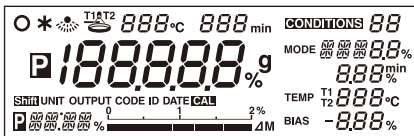
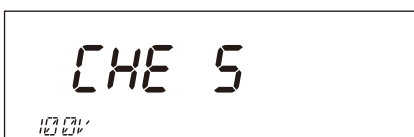
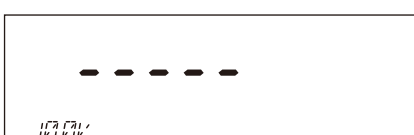
Before beginning a measurement, check to make sure that there is nothing remaining in the sample dish. Also be sure that all parts of the main unit are firmly fixed in place and be sure that the heater lid has been closed firmly before starting to perform measurements.

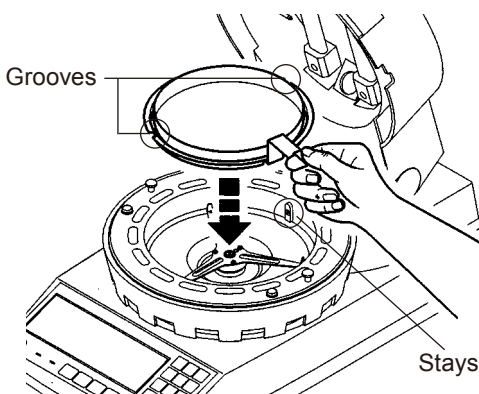
Also be sure to check on a regular basis that the main unit is level and readjust the height adjustment legs if necessary. (See “6. Assembly and Installation of Main Unit” on p. 14 for instructions on how to do so.)

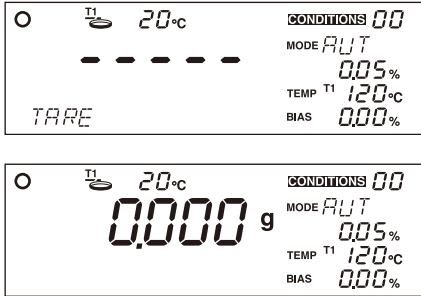
Operating instructions	Display
<p>① Turn on the power switch</p> <p>Turn on the power switch located at the rear of the unit. When you turn on the power for the first time after purchasing your tester, a tone will sound, the display will light up with all items lit and then change to display first ‘CHE5’ and then a string of dashes (i.e., ‘-----’). At the bottom left of the display will be displayed the power settings specified (as described in step ④ of “6. Assembly and Installation of Main Unit” on p. 14) with the display reading ‘100V’ when the power settings have been set to 100~120V and reading ‘220V’ when they have been set to 220~240V.</p> <p>If using the tester in a country that does not use 100V power, then this is the time when you should specify the power settings to be used. (See step ③ of “10-2-8 Specifying the power settings” on p. 47 for instruction on how to do so.)</p> <ul style="list-style-type: none"> * When using the tester in Japan, the settings should be left unchanged. Check to make sure that the display reads ‘100V’ and then press the key. As the power setting continues to be displayed in the lower left of the display, the center of the display will change to display ‘CHE4’, ‘CHE3’, ... , ‘CHE0’ and a tone will sound and the display will change to weight reading display mode. * When the power is turned on for the second or subsequent times, a tone will sound, the display will light up with all items lit, the display will change to display ‘CHE5’, ‘CHE4’, ... , ‘CHE0’ while the currently specified power setting is displayed, and then a tone will sound again and the display will change to weight reading display mode. * Note that it is recommended that you always turn on the tester about half an hour before use in order to obtain consistent measurements. 	<div style="text-align: center;">  </div> <div style="text-align: center; margin: 10px 0;">  </div> <div style="text-align: center; margin: 10px 0;">  </div> <div style="text-align: center; margin: 10px 0;">  </div> <div style="text-align: center;">  </div> <ul style="list-style-type: none"> * Display will show default settings at the time of shipment. (See p. 24, “9-2-1 Selecting the CONDITIONS (Measuring conditions storage area)”.)
<p>② Specifying settings</p> <p>When performing measurements for the first time, or when you wish to change current settings before measuring, then you should specify the settings required for measuring here. (See “9. Specifying Measuring Conditions” on p. 23 and “10. Menu settings” on p. 36 for instructions on how to do so.)</p>	
<p>③ Placing the sample dish in the tester</p> <p>Open the heater lid, place the sample dish on the handler, and place the handler into the tester, being sure when you do so that the grooves of the handler fit smoothly over the projection located at the rear of the wind shield.</p> <ul style="list-style-type: none"> * If you have already placed the sample dish and handler (as described in “6. Assembly and Installation of Main Unit”) then proceed directly to the next step. * When using an aluminum foil sheet, glass fiber or other wrapping because of the nature of the sample being measured, place the wrapping on top of the sample tray. 	

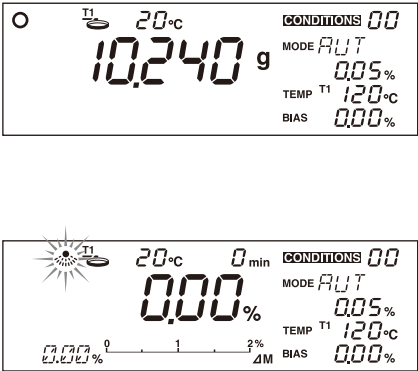
Operating instructions	Display
<p>④ Performing a tare</p> <p>Shut the heater lid, check to make sure that the steady-state mark (○) is displayed, and press the Tare/Reset key. A series of hyphens and the word 'TARE' will be displayed, the sample dish will move vertically and a tare will be performed. A sharp tone will then sound and the word 'TARE' will disappear from the display, a weight of '0.000 g' will be displayed and the tare will then be complete.</p> <p>* Always be sure that the heater lid is closed when performing a tare. Also make sure that the tester is not exposed to drafts or breezes, or subjected to any vibrations when a tare is being performed.</p>	 <p>The top screenshot shows the display with a stability indicator (○), a pan icon, and '20°C'. The word 'TARE' is displayed on the left, and a series of dashes is in the center. On the right, it shows 'CONDITIONS 00', 'MODE AUT', '0.05%', 'TEMP T1 120°C', and 'BIAS 0.00%'.</p> <p>The bottom screenshot shows the same display but with '0.000 g' displayed in the center.</p>
<p>⑤ Placing a sample in the tester</p> <p>Open the lid to the heater and place the sample inside. Be sure to place the sample as flatly as possible into the tester so that heat is applied evenly to the sample during measurement. (See “7. Tips on how to ensure accurate measurements” on p. 17 for further information.)</p>	 <p>The screenshot shows the display with a stability indicator (○), a pan icon, and '20°C'. The weight '10.240 g' is displayed in the center. On the right, it shows 'CONDITIONS 00', 'MODE AUT', '0.05%', 'TEMP T1 120°C', and 'BIAS 0.00%'.</p>
<p>⑥ Beginning measurement</p> <p>Close the lid of the heater, check to make sure that the stability indicator (○) is being displayed, and then press the Start/Stop key. The display will switch from a display of the weight (i.e., grams) to a percentage display and the measuring time will be displayed. The heating indicator LED will light up red and the heater mark (☀️) will flash on the indicator, and drying will start.</p> <p>* There may be times when the stability indicator (○) is not displayed because of external vibrations or drafts or breezes. While it is possible to perform measurements at such times, there may be cases when it is impossible to obtain accurate measurements at such times. You should always be sure to conduct measurements in a location as free as possible of vibrations, drafts, breezes, or any other harmful influences.</p>	 <p>The top screenshot shows the display with a stability indicator (○), a pan icon, and '20°C'. The weight '10.240 g' is displayed in the center. On the right, it shows 'CONDITIONS 00', 'MODE AUT', '0.05%', 'TEMP T1 120°C', and 'BIAS 0.00%'.</p> <p>The bottom screenshot shows the display with a stability indicator (○), a pan icon, and '20°C'. The percentage '0.00%' is displayed in the center, and '0 min' is shown to its right. On the right, it shows 'CONDITIONS 00', 'MODE AUT', '0.05%', 'TEMP T1 120°C', and 'BIAS 0.00%'. At the bottom, there is a scale indicator with '0', '1', and '2%' markings.</p>

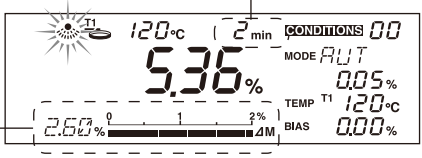
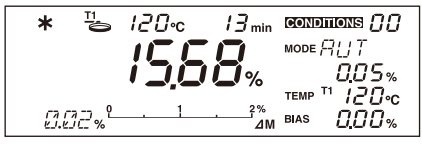
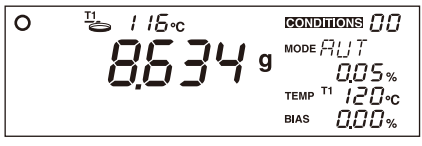
Operating instructions	Display
 <ul style="list-style-type: none"> * Never open the lid to the heater while a measurement is in progress. Doing so is not only hazardous but also could contribute to making it impossible to obtain accurate measurements. If it is absolutely necessary to open the lid to the heater while a measurement is in progress to view the sample material (or for some other reason) limit the time the lid is opened to 15 seconds or less. (A warning buzzer will sound 10 seconds after the lid is opened and if the lid remains open for more than 15 seconds, the measurement operation will be aborted and an 'ER306' error code will be displayed.) * Pressing the Start/Stop key while the heater lid is open will cause a safety alert buzzer to sound and measuring to be stopped. 	
<p>⑦ Measuring time display</p> <p>The time indicator during measurement is elapsed time (minutes) during AUTO (automatic stop). It is remaining time during TIME (time measurement).</p> <ul style="list-style-type: none"> * The change in moisture content over each 30-second interval is displayed numerically and in scalar format (where the scalar display may display a maximum change of 2 percent/30 seconds). * Weight is performed automatically once per minute (or once every 30 seconds when near the end of the measuring time) while measuring moisture content. * To stop measuring when in the midst of a measuring operation, press the Start/Stop key. 	
<p>⑧ Completion of measurement</p> <p>When the measuring operation has been completed, the heater on LED and the heater mark (☀️) will disappear, the measurement completed indicator (★) will be displayed, and a tone will ring for a period of 10 seconds. To turn off the tone, press the Start/Stop key. The results of the measurement will be displayed and remain displayed on the display.</p> <ul style="list-style-type: none"> * If the unit is connected to a printer (option), pressing the Enter key while a hold message is being displayed will cause the signature field to be printed. (See "14-1 Sample Printer Output" on p. 61 for further information.) 	
<p>⑨ Resetting the display</p> <p>Pressing the Tare/Reset key at this point causes the display of the results of the measurement (i.e., moisture content) to disappear and be replaced by a display of the weight of the sample after drying.</p> <ul style="list-style-type: none"> * Note that a reset cannot be performed until the completion tone has stopped ringing. 	
<p>⑩ Disposing of samples after measurement</p> <p>Open the lid to the heater, raise the handler vertically, remove the sample dish, and dispose of the sample.</p> <ul style="list-style-type: none"> * Note that the sample and sample dish may be very hot and you should accordingly be careful in handling them at this time. 	

Operating instructions	Display
<p>⑪ Preparing to perform the next measurement</p> <p>Leave the lid to the heater open to allow the tester to cool. When performing sequential measurements, leave an interval of a few minutes and make sure that the tester has cooled before proceeding to the next measurement.</p> <p>The time that the temperature indicator LED changes from orange to yellow-green (39°C or less), is a criterion for starting the repeat measurement.</p> <p>* The indicated temperature at this time must be set as T1 indicator in advance. Press the  key to switch between the T1 and T2 indicators.</p> <p>You should also keep a spare (cooled) sample dish available to use in the next measurement. (See “7. Tips on how to ensure accurate measurements” on p. 17 for further information.)</p> <p>When ready, return to step ③ and begin the next measurement.</p>	
<p>⑫ Turning off the power</p> <p>When all the measurements have been completed, pull the power plug from the power outlet. And when not using the main unit, always pull the power plug from the power outlet.</p>	

9. Specifying Measuring Conditions

When using this tester to measure moisture or solid content, it is necessary to first specify the conditions (e.g., drying temperature or measuring mode) to be used in performing the measurement. The settings which may be specified are as described below. When necessary, it is also possible to save sets of measuring conditions (i.e., drying temperature, measuring mode, and bias).

9-1 Types of Settings

Setting	Display during specification of setting	Description
CONDITION	CONDITION 0~9 (Measuring conditions storage areas 0~9)	Used to select the area to which measuring conditions are to be stored. There are 10 storage areas labeled from 0 to 9. (See p. 24, "9-2-1 Selecting the CONDITIONS (Measuring conditions storage area)".)
MODE (Measuring mode)	AUT (AUTO: Automatic halting mode)	In automatic halting mode, measuring is brought to a halt whenever the change in moisture content over two consecutive 30-second periods falls below the specified conditions for automatic halting. (For further information, see 9-2-2 "1) Specifying settings for AUTO (Automatic halting mode)" on p. 25.)
	TIM (TIME: Timed halting mode)	Causes measuring to be completed when the specified amount of time has elapsed. (For further information, see 9-2-2 "2) Specifying settings for TIME (Timed halting mode)" on p. 26.)
	RPD (RAPID: High-speed drying mode)	Causes the sample material to be rapidly dried until the amount of change in moisture content over a period of 30 seconds falls below the specified quantity and for drying to then be continued at the specified drying temperature. (For further information, see 9-2-2 "3) Specifying settings for RAPID (High-speed drying mode)" on p. 27.)
	SLW (SLOW: Low-speed drying mode)	In low-speed drying mode, the temperature is raised more gradually than when performing measurements under normal conditions, with it taking about 5 minutes from the time when measuring begins until the temperature reaches the specified drying temperature. (For further information, see 9-2-2 "4) Specifying settings for SLOW (Low-speed drying mode)" on p. 29.)
	STP (STEP: Stepped drying mode)	In stepped drying mode it is possible to specify a separate drying temperature and separate measuring time over up to 5 step intervals. (For further information, see 9-2-2 "5) Specifying settings for STEP (Stepped drying mode)" on p. 30.)
	CMP (COMPARE: Comparative measuring mode)	Comparative measuring mode is used to measure the bias (i.e., the difference between the measurement corresponding to that obtained in automatic halting mode and the predicted measurement value) needed in order to perform measurements in predictive measuring mode. (For further information, see 9-2-2 "6) Specifying settings for COMPARE (Comparative measuring mode)" on p. 32.)
	PRD (PREDICT: Predictive measuring mode)	In predictive measuring mode, the intermediate results of drying are used to predict future changes and to calculate the predicted measurement and thereby shorten the amount of time used in measurement. (For further information, see 9-2-2 "7) Specifying settings for PREDICT (Predictive measuring mode)" on p. 33.)
TEMP (Drying temperature)	○○○	This parameter may be used to specify the drying temperature. The drying temperature may be set within a range from 30°C to 180°C when setting thermistor (T1), and in a range from 30°C to 250°C in 1-degree increments when setting the radiation temperature (T2). (For further information, see "9-2-3 TEMP (Drying temperature)" on p. 34.)
BIAS (Bias value)	○.○○	This parameter is used to specify a numeric value to be used to correct measurements for bias. A bias anywhere in the range of from -9.99% to 9.99% may be specified in 0.01% increments. (For further information, see "9-2-4 Bias" on p. 35.)

9-2 Descriptions of Individual Measuring Condition Settings

For a detailed description of individual measuring condition settings, see the instructions on how to specify the settings for each item in subsection 9-2-1 and subsequent subsections.

- ① To start specifying measuring condition settings:
Press the **Condition** key at a time when the display shows a weight reading.
- ② If any password other than the default password of '0000' has been specified, then a 'PASS' message will be displayed in the weight display area. When this message is displayed, follow the instructions provided on p. 46, "10-2-7 Specifying a password", to enter a password. If the password entered is incorrect, the display will return to the weight display.
- ③ Selecting individual measuring conditions:
First a '**CONDITIONS**' message will flash on the display. Pressing the **Select** key at this time causes the flashing item to change in sequence from **MODE** to **TEMP** to **BIAS** to **CONDITIONS** and back to **MODE** and so on each time the key is pressed. When the item for which you wish to specify settings is flashing, press the **Enter** key. At this point it will be possible to specify the settings for the flashing item.
- ④ To finish specifying measuring condition settings:
Pressing the **Condition** key at a time when any settings item is flashing causes the settings specified to take effect and cause the display to return to the normal weight display.

9-2-1 Selecting the CONDITIONS (Measuring conditions storage area)















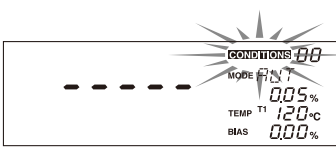

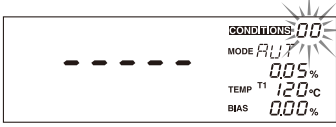
Below is described the procedure used to select the area in which measuring conditions are to be saved.

This operation causes the measuring mode, drying temperature, bias, and other currently specified measuring conditions to be saved to the selected area.

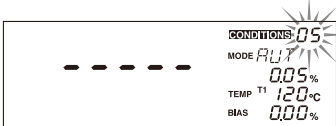
* At the time of shipment, the following settings are stored in measuring conditions storage areas 0~99:

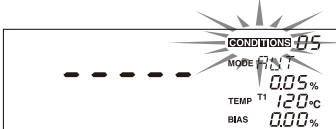
Measurement standard : Wet Base
Drying temperature : T1 (Thermistor), 120°C
Measuring mode : Automatic halting mode (Change in water content of 0.05% over 30seconds)
Bias : 0.00%

■ Specifying settings for the CONDITIONS (Measuring conditions storage area)

Step	Key(s) used	Operating instructions	Display
①		With the display displaying the weight in grams, press the  key.	
②		If a password has been specified, the message 'PASS' will be displayed to indicate that a password should be entered. Follow the instructions in "10-2-7 Specifying a password" on p. 46 to enter the password.	
③		The 'CONDITIONS' display area will begin to flash.	
④		Press the  key. This will cause the highlight to move to the measuring conditions area number and for the measuring conditions area number to begin to flash.	
⑤	 → 	Press the  →  keys to select a measuring conditions area number from 0 to 99. In this example, we selected area number '5'.	
⑥		When the desired measuring conditions area number starts flashing, press the  key. The selected measuring conditions area number will change from a flashing to a constantly lit display and the 'CONDITIONS' message will begin to flash instead.	
⑦	 	If you wish to specify other measuring conditions settings, press the  key to select the setting to be specified. To exit from specifying measuring conditions settings, press the  key instead.	

9-2-2 Selecting the MODE (Measuring mode)

The 'MODE' (measuring mode) setting is used to specify the conditions under which measuring is to be completed. As shown in the table in subsection "9-1 Types of Settings", the mode may be set to one of seven methods.

1) Specifying settings for AUTO (Automatic halting) mode

In automatic mode, measurement is brought to completion when the amount of change in moisture content over a period of 30 seconds falls to a level below a specified threshold level. The automatic halting threshold level may be specified in 0.01-percent increments from 0.01 to 0.1percent.

Specifying a smaller percentage causes measurements to approach a point of equilibrium, but more time is then required for measurement. Specifying a higher percentage lessens the amount of time required for measurement, but measuring is completed while there may still be a wide variation in measurements. The automatic halting conditions should be specified in accordance with your objectives and the type of sample being measured.

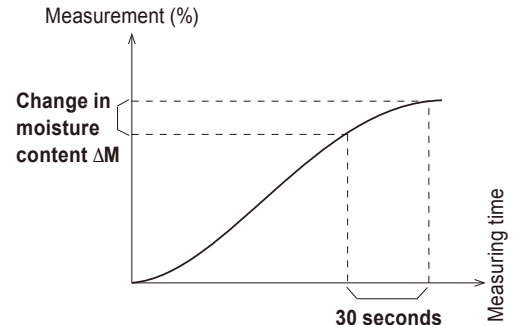











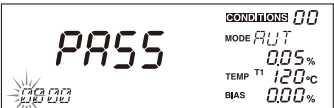

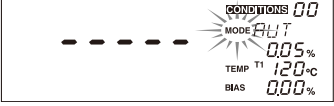

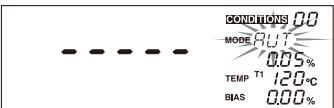

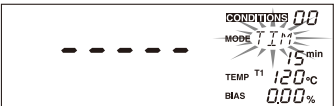

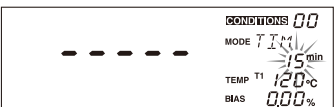



Step	Key(s) used	Operating instructions	Display
①		With the display displaying the weight in grams, press the key.	
②		If a password has been specified, the message 'PASS' will be displayed to indicate that a password should be entered. Follow the instructions in "10-2-7 Specifying a password" on p. 46 to enter the password.	
③		The 'CONDITIONS' display area will begin to flash. Press the key until 'MODE' begins to flash.	
④		With the 'MODE' display area flashing, press the key. This will cause the highlight to shift to measuring mode selection and for the currently specified measuring mode to begin flashing.	
⑤		Press the key until 'AUT' begins to flash. * Since 'AUT' will already be flashing at the point, proceed directly to the next step.	
⑥		When 'AUT' begins to flash, press the key. This will cause the automatic halting mode settings to become active and for the automatic halt conditions (i.e., amount of change in moisture content per 30 seconds) to begin flashing.	
⑦		Press the keys to select the desired automatic halt conditions. Note that here we specify a setting of 0.1 percent. In this case, press "1" and then "0".	
⑧		When the desired automatic halt conditions setting begins to flash, press the key. The automatic halt conditions setting will change from a flashing to a constantly lit display and 'MODE' will begin to flash instead.	
⑨	 	If you wish to specify other measuring conditions settings, press the key to select the setting to be specified. To exit from specifying measuring conditions settings, press the key instead.	

2) Specifying settings for TIME (Timed halting) mode

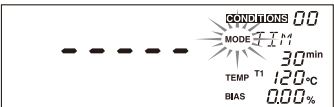
In timed halting mode, the measuring time is specified before the test and the sample is dried to determine its moisture (or solid) content. When the specified measuring time is reached, the test is halted.

Measuring time may be specified in 1-minute increments anywhere in a range from 1 to 240 minutes or measuring may be specified to be performed over a continuous period of 12 hours.

Step	Key(s) used	Operating instructions	Display
①		With the display displaying the weight in grams, press the  key.	
②		If a password has been specified, the message 'PASS' will be displayed to indicate that a password should be entered. Follow the instructions in "10-2-7 Specifying a password" on p. 46 to enter the password.	
③		The 'CONDITIONS' display area will begin to flash. Press the  key until 'MODE' begins to flash.	
④		With the 'MODE' display area flashing, press the  key. This will cause the highlight to shift to measuring mode selection and for the currently specified measuring mode to begin flashing.	
⑤		Press the  key until 'TIM' begins to flash. * If 'TIM' is already flashing, then proceed directly on to the next step.	
⑥		When 'TIM' begins to flash, press the  key. This will cause the measuring time settings to become active and for the currently specified measuring time to begin to flash.	
⑦	 → 	Press the  →  keys to select the desired measuring time. Note that here a time of '30 minutes' is specified. * When setting 12 hours, enter [2], [4], and [1].	
⑧		When the desired measuring time begins flashing, press the  key. The specified measuring time will change from a flashing to a constantly lit display and 'MODE' will begin to flash instead.	
⑨	 	If you wish to specify other measuring conditions settings, press the  key to select the setting to be specified. To exit from specifying measuring conditions settings, press the  key instead.	

3) Specifying settings for RAPID (High-speed drying) mode













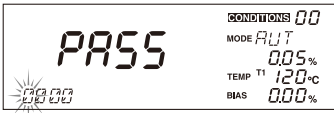

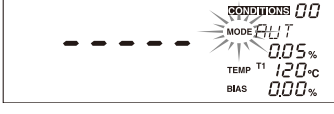

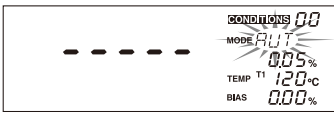
During the initial phase of measurement, the material is dried at a temperature higher than the specified drying temperature to speed up drying and reduce the amount of time required for performing measurements. Once drying has proceeded to a sufficient point, the temperature is returned to the specified temperature and drying is continued at that temperature to help prevent burning.

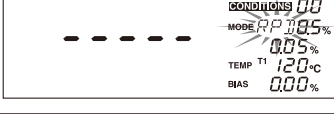











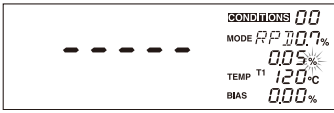



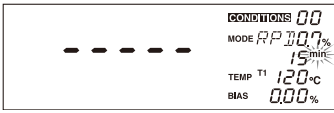

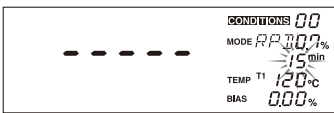



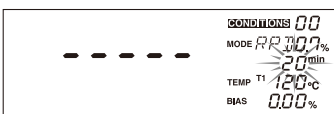

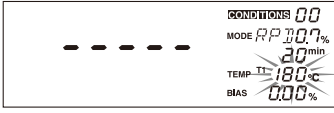

In this mode, it is necessary to specify the drying temperature to be used during the initial phase of measurement (i.e., the rapid drying temperature) and the amount of change in moisture content over a 30-second interval needed to maintain that temperature (i.e., the conditions under which the rapid drying temperature is to be maintained). Rapid drying will continue to be performed until the change in moisture content over a 30-second interval (ΔM) falls to a level below the specified level at which rapid drying conditions are to be maintained, and after that drying will continue at the specified drying temperature.

The amount of change in moisture content over which rapid drying is to be continued may be specified in 0.1-percent increments from 0.1 to 9.9 percent.

- * **Note that a higher value should be specified for the rapid drying temperature than the regular drying temperature.**
- * **Note that it may take a considerable amount of time for the temperature to be lowered from the rapid drying temperature to the regular drying temperature.**

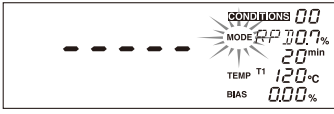
Specifying a relatively low degree of change in moisture content or specifying a high rapid drying temperature may reduce the amount of time required to perform a measurement, but depending on the sample material being measured doing so could result in the material becoming burnt or make it impossible to obtain accurate measurements. Conversely, specifying a relatively high degree of change in moisture content or specifying a low rapid drying temperature could make it difficult to obtain the effects expected from performing rapid drying. Either AUTO (automatic halting) or TIME (timed halting) may be specified as the halt condition.

Step	Key(s) used	Operating instructions	Display
①		With the display displaying the weight in grams, press the  key.	
②		If a password has been specified, the message 'PASS' will be displayed to indicate that a password should be entered. Follow the instructions in "10-2-7 Specifying a password" on p. 46 to enter the password.	
③		The 'CONDITIONS' display area will begin to flash. Press the  key until 'MODE' begins to flash.	
④		With the 'MODE' display area flashing, press the  key. This will cause the highlight to shift to measuring mode selection and for the currently specified measuring mode to begin flashing.	
⑤		Press the  key until 'RPD' begins to flash. * If 'RPD' is already flashing, then proceed directly on to the next step.	
⑥		When 'RPD' begins to flash, press the  key. The highlight will then be transferred to the specification of the rapid drying temperature and the numeric display will begin to flash.	
⑦	 → 	Press the  →  keys to select the desired rapid drying temperature maintenance conditions. In this example we have specified a degree of change of 0.7%. In this case, press "0" and then "7".	

Step	Key(s) used	Operating instructions	Display
⑧		When the desired the rapid drying temperature maintenance conditions begins to flash, press the  key. The high-speed settings will then be set and the highlight will shift to the selection of the halting conditions. The units area for timed halting mode ('min') or automatic halting mode ('%') will begin to flash.	
⑨		Pressing the  key will cause the units to switch between minutes ('min') and a percentage ('%'). Press the  key until the desired units are displayed.	
⑩		When the desired units for the halting conditions (i.e., minutes or a percentage) begin to flash, press the  key. This will cause the highlight to shift to the specification of the halting conditions and the numerical field begin to flash.	
⑪	 → 	Press the  →  keys to select the desired halting conditions. In this example, timed halting (20 minutes) is specified.	
⑫		When the desired time or percentage flashes, press the  key. The temperature field with a value of 180°C or the rapid drying temperature last specified will begin to flash. (The initial default values is 180°C.)	
⑬	 → 	Press the  →  keys to select the desired rapid drying temperature. In this example the temperature is set to 140°C.	
⑭		When the desired rapid drying temperature is displayed, press the  key. The press the 'MODE' field will then begin to flash.	
⑮	 	If you wish to specify other measuring conditions settings, press the  key to select the setting to be specified. To exit from specifying measuring conditions settings, press the  key instead.	

4) Specifying settings for SLOW (Low-speed drying) mode

In low-speed drying mode, the temperature is raised more gradually than when performing measurements under normal conditions, with it taking about 5 minutes from the time when measuring begins until the temperature reaches the specified drying temperature.

Either 'AUTO' (automatic halting mode) or 'TIME' (timed halting mode) may be specified to define the conditions under which measuring is to be halted.













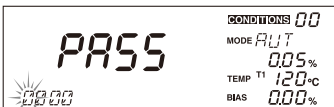

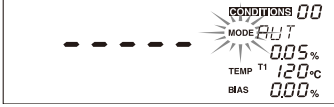

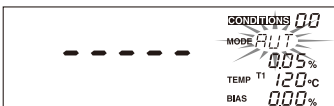

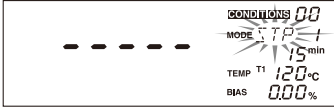









Step	Key(s) used	Operating instructions	Display
①		With the display displaying the weight in grams, press the key.	
②		If a password has been specified, the message 'PASS' will be displayed to indicate that a password should be entered. Follow the instructions in "10-2-7 Specifying a password" on p. 46 to enter the password.	
③		The 'CONDITIONS' display area will begin to flash. Press the key until 'MODE' begins to flash.	
④		With the 'MODE' display area flashing, press the key. This will cause the highlight to shift to measuring mode selection and for the currently specified measuring mode to begin flashing.	
⑤		Press the key until 'SLW' begins to flash. * If 'SLW' is already flashing, then proceed directly on to the next step.	
⑥		When 'SLW' begins to flash, press the key. The highlight will then shift to specification of low-speed drying mode settings where the halting conditions must be specified. The units area for timed halting mode ('min') or automatic halting mode ('%') will begin to flash.	
⑦		Pressing the key will cause the units to switch between minutes ('min') and a percentage ('%'). Press the key until the desired units are displayed.	
⑧		When the desired units for the halting conditions (i.e., minutes or a percentage) begin to flash, press the key. This will cause the highlight to shift to the specification of the halting conditions and the numerical field begin to flash.	
⑨	→	Press the → keys to select the desired halting conditions. In this example, timed halting (20 minutes) is specified.	
⑩		When the desired time or percentage flashes, press the key. The specified halting conditions will then change from flashing to a constantly lit display and 'MODE' will begin to flash.	
⑪	 	If you wish to specify other measuring conditions settings, press the key to select the setting to be specified. To exit from specifying measuring conditions settings, press the key instead.	













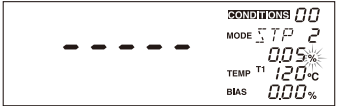

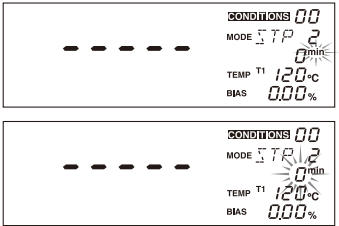



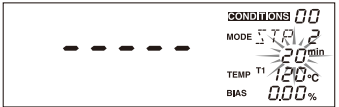

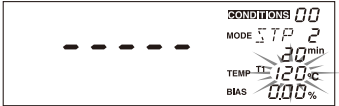

5) Specifying settings for STEP (Stepped drying) mode

In stepped drying mode it is possible to specify separate measuring conditions for up to a maximum of 5 steps. Specifying a separate drying temperature and separate measuring time for each step makes it possible to specify finer-grained sets of measuring conditions.

In Step 1, timed halting mode must be specified as the mode used to define halting conditions. In Step 2 and subsequent steps, it is possible to select between either automatic halting mode or timed halting mode.

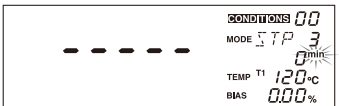
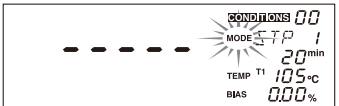
- * If automatic halting mode is selected as the mode to be used in Step 2 or later, that step becomes the final step. Similarly, when timed halting mode is selected and a value of '0' is specified as the measuring time, the previous step becomes the final step.

Step	Key(s) used	Operating instructions	Display
①		With the display displaying the weight in grams, press the  key.	
②		If a password has been specified, the message 'PASS' will be displayed to indicate that a password should be entered. Follow the instructions in "10-2-7 Specifying a password" on p. 46 to enter the password.	
③		The 'CONDITIONS' display area will begin to flash. Press the  key until 'MODE' begins to flash.	
④		With the 'MODE' display area flashing, press the  key. This will cause the highlight to shift to measuring mode selection and for the currently specified measuring mode to begin flashing.	
⑤		Press the  key until 'STP' begins to flash. * If 'STP' is already flashing, then proceed directly on to the next step.	
⑥		When 'STP' begins to flash, press the  key. This will cause 'STP' to change from a flashing to a constantly lit display, for the highlight to shift to the specification of the measuring time for Step 1, and for the measuring time to begin to flash.	
⑦	 → 	Press the  →  keys to select the desired measuring time. The time may be set to a length of anywhere from 1 to 240 minutes in 1 minute increments. Note that here a time of 20 minutes has been specified.	
⑧		When the desired measuring time flashes, press the  key. The measuring time will change from a flashing to a constantly lit display the highlight will shift to the specification of the drying temperature, and the drying temperature will begin to flash.	
⑨	 → 	Press the  →  keys to select the desired drying temperature. The temperature may be set to a temperature of anywhere from 30°C to 180°C (T2 is selectable, from 30°C to 250°C) in 1 degree increments. Note that here a temperature of 105°C has been specified.	
⑩		When the desired drying temperature flashes, press the  key. The step displayed will change from 'STP 1' to 'STP 2' and the units area for timed halting mode ('min') or automatic halting mode ('%') will begin to flash.	

Step	Key(s) used	Operating instructions	Display
⑪		Pressing the  key will cause the units to switch between minutes ('min') and a percentage ('%'). Press the  key until the desired units are displayed.	
⑫		When the desired units for the halting conditions (i.e., minutes or a percentage) begin to flash, press the  key. This will cause the highlight to shift to the specification of the halting conditions and the numerical field begin to flash. * Note that this step becomes the final step if automatic halting mode (i.e., a percentage) is specified here.	
⑬	 → 	Press the  →  keys to select the desired halting conditions. Note that here a time of 20 minutes has been specified. (When automatic halting has been specified as the operation mode, the degree of change in moisture content may be specified as anywhere from 0.01 to 0.1percent in 0.01-percent increments.) * Note that the previous step becomes the final step if timed halting mode has been selected and a measuring time of '0' is specified here. * Note that it is impossible to perform continuous measurement (over 12 hours) in this mode. The maximum drying time for each step is 240 minutes.	
⑭		When the desired halting conditions begin to flash, press the  key. This will the display of the halting conditions to change from a flashing to a constantly lit display, for the highlight to shift to the specification of the drying temperature for Step 2, and for the drying temperature to begin to flash.	
⑮	 → 	Press the  →  keys to select the desired drying temperature. Note that here a temperature of 100°C has been specified.	
⑯		When the desired drying temperature is displayed, press the  key. The step displayed will change from 'STP 2' to 'STP 3' and control will shift to the specification of halting conditions. At this point, you must go back to step ⑪ and repeat all subsequent steps up to this step until settings have been specified for all steps up to the final step.	
⑰		When the settings for the final step have been specified, 'MODE' will begin to flash.	
⑱	 	If you wish to specify other measuring conditions settings, press the  key to select the setting to be specified. To exit from specifying measuring conditions settings, press the  key instead.	

6) Specifying settings for COMPARE (Comparative measuring) mode

Comparative measuring mode is used to calculate the bias (i.e., the difference between the predicted measurement and the measurement which would be obtained when operating in automatic halting mode) needed when conducting predictive measurements.

















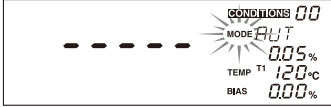





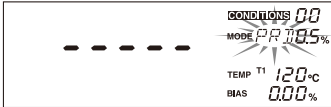



When conducting predictive measurements, this mode should be used first to calculate the bias. (For further information, see “● Comparative measuring mode” and “● Predictive measuring mode” on p. 56.)

Step	Key(s) used	Operating instructions	Display
①		With the display displaying the weight in grams, press the key.	
②		If a password has been specified, the message 'PASS' will be displayed to indicate that a password should be entered. Follow the instructions in “10-2-7 Specifying a password” on p. 46 to enter the password.	
③		The 'CONDITIONS' display area will begin to flash. Press the key until 'MODE' begins to flash.	
④		With the 'MODE' display area flashing, press the key. This will cause the display to shift to measuring mode selection and for the currently specified measuring mode to begin flashing.	
⑤		Press the key until 'CMP' begins to flash. * If 'CMP' is already flashing, then proceed directly on to the next step.	
⑥		When 'CMP' begins to flash, press the key. 'CMP' will change from a flashing to a constantly lit display and you will next be required to specify the predicted value convergence range settings (see “I Predicted value convergence range” on p. 55). The current setting for the predicted value convergence range will begin to flash.	
⑦	→	Press the → keys to specify the desired predicted value convergence range. A value of anywhere from 0.1 to 9.9 percent may be specified in 0.1-percent increments. Note that here a value of 0.5% has been selected.	
⑧		When the desired value is displayed, press the key. The flashing display of the predicted value convergence range will change from a flashing to a constantly lit display, and the display will shift to the automatic halting settings, and the setting specifying the degree of change in moisture content over a 30-second period will begin to flash.	
⑨	→	Press the → keys to select the desired automatic halting conditions. A value of anywhere from 0.01 to 0.1 percent may be specified in 0.01-percent increments. Note that here a value of 0.05% has been selected.	
⑩		When the desired automatic halting conditions have been selected, press the key. The specified setting will change from a flashing to a constantly lit display, and 'MODE' will begin to flash.	
⑪	 	If you wish to specify other measuring conditions settings, press the key to select the setting to be specified. To exit from specifying measuring conditions settings, press the key instead.	

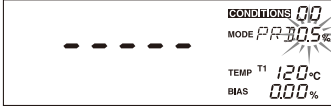
7) Specifying settings for PREDICT (Predictive measuring) mode

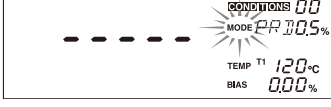
This mode is designed for use in reducing the amount of time required for performing measurements by calculating a predicted final measurement from data obtained on changes in moisture content while drying is still in progress.

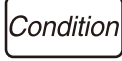
Note that some materials have properties which make it difficult to obtain accurate predictions. Also note that predictive measuring mode should be used only after conducting measurements in comparative measuring mode to check the precision of measurement and the possible effectiveness in terms of shortening the measuring time.

















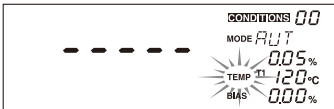

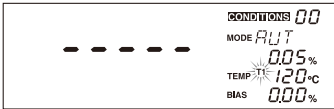

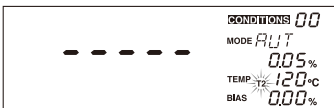

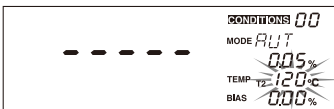
Step	Key(s) used	Operating instructions	Display
①		With the display displaying the weight in grams, press the  key.	
②		If a password has been specified, the message 'PASS' will be displayed to indicate that a password should be entered. Follow the instructions in "10-2-7 Specifying a password" on p. 46 to enter the password.	
③		The 'CONDITIONS' display area will begin to flash. Press the  key until 'MODE' begins to flash.	
④		With the 'MODE' display area flashing, press the  key. This will cause the highlight to shift to measuring mode selection and for the currently specified measuring mode to begin flashing.	
⑤		Press the  key until 'PRD' begins to flash. * If 'PRD' is already flashing, then proceed directly on to the next step.	
⑥		When 'PRD' begins to flash, press the  key. 'PRD' will then change from a flashing to a constantly lit display and you will next be required to specify the predicted value convergence range settings (see "● Predicted value convergence range" on p. 55). The current setting for the predicted value convergence range will begin to flash.	
⑦	 → 	Press the  →  keys to enter the desired predicted value convergence range. A value of anywhere from 0.1 to 9.9 percent may be specified in 0.1-percent increments. Note that here a value of 0.5% has been selected. (Enter [0] and [5].)	
⑧		When the desired automatic halting conditions have been selected, press the  key. The specified setting will change from a flashing to a constantly lit display, and 'MODE' will begin to flash.	
⑨	 	If you wish to specify other measuring conditions settings, press the  key to select the setting to be specified. To exit from specifying measuring conditions settings, press the  key instead.	

9-2-3 TEMP (Drying temperature)

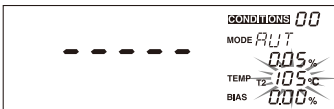
The following describes the procedure to be followed to specify the drying temperature to be used in drying samples when conducting measurements. While the drying temperature is set to 120°C as the default temperature at the time of shipment, depending on the type of sample, its moisture content, or other conditions, the proper drying temperature to use may vary. To find the proper drying temperatures to be used for different types of materials, conduct repeated measurements until you find the correct temperature to use for each type of material. The temperature may be set to a temperature of anywhere from 30°C to 180°C during T1 (thermistor setting) and from 30°C to 250°C during T2 (radiation temperature) setting, in 1-degree increments.

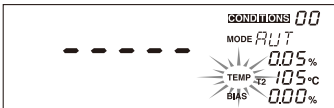
- * While T1 is primarily a measurement of the ambient temperature inside the heating chamber, T2 is a measurement of the surface temperature of the sample. (see p. 53 “12-4 Relationship of T1 and T2”.)
- * Generally drying is performed more quickly when a higher drying temperature is specified, but if the temperature specified is too high it might result in the sample becoming burnt, thus making it impossible to obtain accurate measurements. (In this case, the moisture content is a little high.)
- * Be careful with the drying temperature, because the T1 measurement is identical to that by the FD-720, but with other conventional models (FD-600, 610, 100, 240, etc.) the drying temperature differs.
- * The temperature indicator can display either T1 or T2. Pressing the **Shift** key switches the indicator.

■ Specifying settings for the TEMP (Drying temperature)













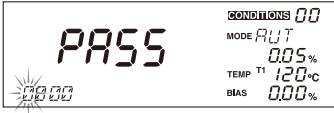

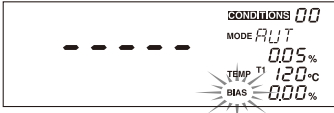

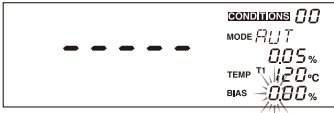
Step	Key(s) used	Operating instructions	Display
①		With the display displaying the weight in grams, press the  key.	
②		If a password has been specified, the message 'PASS' will be displayed to indicate that a password should be entered. Follow the instructions in “10-2-7 Specifying a password” on p. 46 to enter the password.	
③		The 'CONDITIONS' display area will begin to flash. Press the  key until 'TEMP' begins to flash.	
④		With the 'TEMP' indicator flashing, press the  key. This will allow a switch to the control temperature setting, and a thermometer used for currently specified control (T1 or T2) will flash.	
⑤		The thermometer used for control (T1: thermistor, T2 radiation thermometer) is selected by the  key.	
⑥		After selecting the desired control thermometer, press the  key. This will cause a switch to the drying temperature setting and the drying temperature that is currently specified will flash.	
⑦	 → 	Press the  →  keys to select the desired drying temperature. Note that here a temperature of 105°C has been specified.	
⑧		When the desired drying temperature begins to flash, press the  key. The display of the specified temperature will change from a flashing to a constantly lit display and the 'TEMP' indicator will begin to flash instead.	
⑨	 	If you wish to specify other measuring conditions settings, press the  key to select the setting to be specified. To exit from specifying measuring conditions settings, press the  key instead.	

9-2-4 Bias

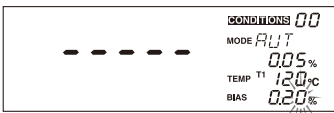
When necessary measurements should and can be corrected for bias. The bias may be specified with a value of anywhere from -9.99 to 9.99% in 0.01% increments. A bias should be specified in cases like those described below.

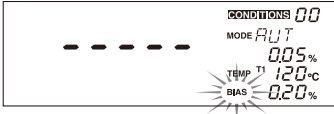
- Many different conditions sometimes result in measured values (as measured using the FD-800) failing to meet with expected (standard) values. When this happens, a bias may be set to correlate the value as measured by the FD-800 and the expected (standard) value.
 - **In most cases it is possible to change the measuring conditions used to make the measurements obtained using the FD-800 to match the expected (standard) values, but when such conditions would cause the sample to be burned, would cause the time required for measurement to become too long, or otherwise result in problems, a bias should be specified instead.**
- When using more than one unit, there may be times when it is impossible to obtain identical measurements even when the same measuring conditions are used, because of differences in the locations where the units are placed or because of differences in the surrounding environment. In such cases, the bias of the unit that is to serve as the standard should be set to zero and the bias of the other units set to account for any such differences.
 - **For information on how to specify the bias when operating in predictive measurement mode, see p. 57, “13-2-1 Calculating the bias to be specified when operating in predictive measurement mode”.**

■ How to set the bias

Step	Key(s) used	Operating instructions	Display
①		With the display displaying the weight in grams, press the  key.	
②		If a password has been specified, the message 'PASS' will be displayed to indicate that a password should be entered. Follow the instructions in “10-2-7 Specifying a password” on p. 46 to enter the password.	
③		The 'CONDITIONS' display area will begin to flash. Press the  key until 'BIAS' begins to flash.	
④		With the 'BIAS' indicator flashing, press the  key. The highlight will then shift to the correction value, and the first digit of the currently specified correction value will begin to flash.	
⑤	 → 	Press the  →  keys to select the desired correction value. Note that here a bias of 0.2% has been specified.	
⑥		When the desired bias is displayed, press the  key. The display of the specified bias will change from a flashing to a constantly lit display, and 'BIAS' will begin to flash instead.	
⑦	 	If you wish to specify other measuring conditions settings, press the  key to select the setting to be specified. To exit from specifying measuring conditions settings, press the  key instead.	

10. Menu Settings

Measurement standards, output data formats, and other parameters may be selected as needed. Always be sure to specify the desired settings before performing measurements. When changing settings, the same procedure is followed as when specifying settings for the first time. All specified settings will be retained in internal memory, so it is not necessary to specify settings when performing a new measurement.

10-1 Types of Menu Settings

Menu	Menu display (Menu items)				Description
UNIT (Measurement standard minimum display unit)	Display 1		Display 2		Used to select one of three possible measurement bases. The minimum units of display for moisture content may also be specified here. (For further information, see "10-2-1 Selecting units (measurement standard and minimum display units)" on p. 37.)
	MW (Wet base)		0.01		
	MD (Dry base) SOL (Solid)		0.1		
OUTPUT (Measurement data output)	Display 1	Display 2		/	Used to specify the format in which data is to be output to a printer or computer. The user may select the destination to which output is to be directed and the format in which data is to be output. When graph output ('GRP') has been selected, it is also possible to specify the minimum and maximum values to be used in the range of measurements. (For further information, see "10-2-2 Specifying the type and format of output" on p. 38.)
	PC (Output to computer)	30S (30 secs.) 1M (1 min.)			
	TBL (Output in tabular format to printer)	2M (2 min.) 5M (5 min.)			
	GRP (Output as graph to printer)	10M (10 min.) FIN (Final result)	0.00% 0.00%		
CODE (Sample code)	0000				Used to specify the sample code to be output to printer or computer. (For further information, see "10--2-3 Specifying sample codes" on p. 41.)
ID (device ID)	00000000				Set the device ID that outputs to the printer or the computer (see "10-2-4 Specifying an ID (device ID)" on p. 42.)
DATE (Date & time)	Display 1	Display 2	Display 3	Display 4	Used to set the internal clock. This date and time is output as the 'Measurement time' printed together with any output data written to a printer or computer. (For further information, see "10-2-5 Setting the date and time" on p. 43.)
	YMD	Year	Month/Day	Time	
	MDY	Month/Day	Year	Time	
	DMY	Day/Month	Year	Time	
CAL (Calibration)	Display 1		Display 2		Used to calibrate the internal scale and radiation thermometer (T2). (For further information, see "10-2-6 CAL (Scale calibration)" on p. 44.)
	BAL		100,000g		
	TEMP		00°C (low temperature) 000°C (high temperature)		

* In addition, it is also possible to set a password (see "10-2-7 specifying a password" on p. 46)

10-2 Descriptions of Individual Menu Items

Descriptions of individual menu items are given in subsection 10-2-1 and below.

- ① Calling up menu settings: To call up menu settings, press the Menu key from the weight display.
- ② Selecting individual menu items: When the Menu key is pressed, the menu item 'UNIT' will light up. Pressing the Select key in this state causes the menu item lit up to change from 'OUTPUT' to 'CODE' to 'ID' to 'DATE' to 'CAL' to 'UNIT'. So when the item of interest is displayed, press the Select key. The settings for the selected item may then be specified.
- ③ Exiting from menu settings: Pressing the Menu key when any menu item is currently lit up exits from menu settings mode and returns to the regular weight display screen.

10-2-1 Selecting units (measurement standard and minimum display units)

1) Selecting the measurement standard

This is used to select and specify the measurement standards to be used when performing measurements. There are three different types of measurement standards: measuring by changes in wet content, measuring by changes in dry content, and measuring by changes in solid content. The standard selected should be chosen in accordance with the type of material being measured.

Type	Menu display	Formula	Description
Wet Base	MW	$\frac{W - D}{W} \times 100 (\%)$	Percentage of evaporated moisture weight with respect to the weight before drying.
Dry Base	MD	$\frac{W - D}{D} \times 100 (\%)$	Percentage of evaporated moisture weight with respect to the weight after drying.
Solid	SOL	$\frac{D}{W} \times 100 (\%)$	Percentage of residual weight after drying with respect to the weight before drying.













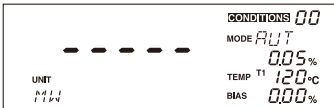

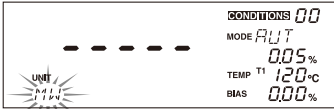



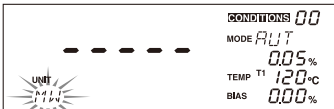

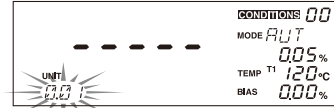

[Notation used in formulas] **W** : Wet weight before measurement **D** : Dry weight after measurement
(While a measurement is being performed, the weight at each point in time is used as the dry weight in calculating measurements.)

2) Selecting the minimum units of display

Select whether the least significant digit to be displayed is to be '0.1%' or '0.01%'.

* Note that the minimum unit of display has no effect when performing comparative measurements.

■ How to select a measurement standard and minimum display units

Step	Key(s) used	Operating instructions	Display
①		With the display displaying the weight in grams, press the  key.	
②		The 'UNIT' menu item will light up and the currently selected measurement base will be displayed.	
③		Press the  key. This will cause the highlight to shift to specification of 'UNIT' settings and for the currently selected measurement base to begin to flash.	
④		Press the  key until the desired measurement base is displayed. The flashing item will change from 'MW' to 'MD' to 'SOL' and back to 'MW' again in sequence each time the  key is pressed. Note that here a wet base ('MW') has been selected.	
⑤		When the desired measurement base begins to flash, press the  key. The currently selected minimum unit of display will begin flashing.	
⑥		Press the  key to select the desired minimum unit of display. Pressing the  key will cause the displayed units to change from 0.01 to 0.1 and back to 0.01 again. In this example, we have specified units of 0.1%.	
⑦		When the desired minimum units of display begins flashing, press the  key. The minimum unit of display will then have been set and control will return to procedure ②.	
⑧	 	If you wish to specify other menu settings, press the  key to select the desired menu item. If you wish to exit from specifying menu settings, press the  key.	

10-2-2 Specifying the type and format of output

The FD-800 may be connected to a separately sold printer or computer so that measurement data can be output to the printer or computer.

- ① There are three types of output formats or output destinations as shown in the table below.

Output destination	Output format	Menu display	Description
Computer	Numeric	PC	This is the setting selected to use the FD-800 Data Logger software FDL-02 or some other RS-232C data read -in software to output to the RS-232C interface.
Printer	Numeric	TBL	This setting causes numeric output to be printed to a separately-sold printer.
	Graph	GRP	This setting causes graph output to be printed to a separately-sold printer.

- ② Any one of the six output intervals shown below may be selected to specify the frequency at which output is to be generated.

The output interval specifies the amount of time which is allowed to elapse during measurement before the next set of output is generated. When there is no need to view intermediate data from before the time when the measurement is completed, 'FIN' may be selected so that only the final results are output.

Output interval	Menu display
Every 30 seconds	30S
Every minute	1M
Every 2 minutes	2M
Every 5 minutes	5M
Every 10 minutes	10M
Final results only	FIN

* 'FIN' should never be selected when graph output has been selected when operating in comparative measuring mode as that would result in no predicted measurements being output.













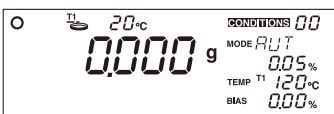

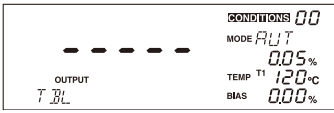

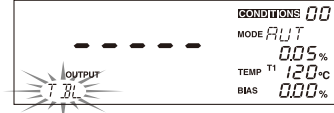



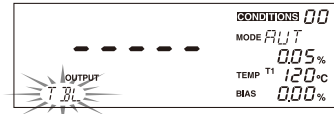

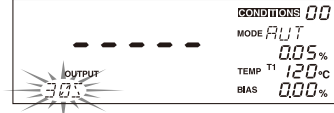
* If it is set to [FIN], measurement settings and measurement conditions are output when the first measurement from carried out the following operations. Measurement conditions are not output after second or later measurements.

- Turned on the power again
- Entered the CONDITIONS (see "9-2-1 Selecting the CONDITIONS (Measuring conditions storage area)" on p.24)
- Entered the Menu (see "10 Menu Settings" on p.36)
- Printed the signature field (see "14 Printing Output to a Printer (Option)" on p.61)
- Specified a device ID (see "10-2-4 Specifying a device ID" on p.42)

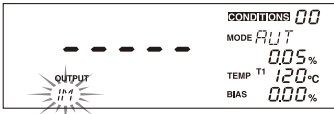





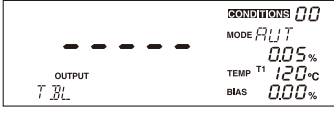



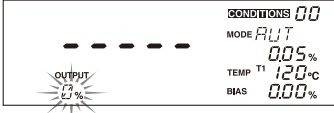



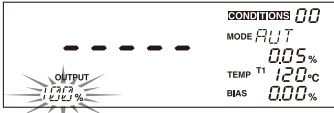

- ③ When graph output has been selected, it is possible to specify the maximum and minimum values of the range of values to be measured in 5-percent increments.

Measurement base	Range of values to be measured
Wet base (%), Solid (%)	Minimum: From 0 to (Maximum -5%) (Specified in 5-percent increments; may be set to any value from 0~95%.)
	Maximum: From (Minimum +5%) to 100 (Specified in 5-percent increments; may be set to any value from 5~100%.)
Dry base (%)	Minimum: From 0 to (Maximum -5%) (Specified in 5-percent increments; may be set to any value from 0~495%.)
	Maximum: From (Minimum +5%) to 500 (Specified in 5-percent increments; may be set to any value from 5~500%.)

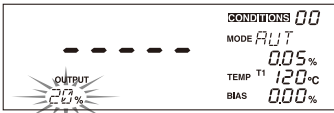
■ How to specify the output format to be used

Step	Key(s) used	Operating instructions	Display
①		With the display displaying the weight in grams, press the  key.	
②		Press the  key until the 'OUTPUT' menu item is displayed.	
③		Press the  key. This will cause the highlight to be shifted to the output settings and cause the currently selected output destination to begin to flash.	
④		Press the  key until the desired output destination has been selected. Pressing the  key here causes the menu item lit up to change from 'TBL' to 'GRP' to 'PC' and back to 'TBL' in sequence each time the  key is pressed. Note that here 'TBL' has been selected.	
⑤		When the desired output destination begins flashing, press the  key. This will cause the highlight to shift to the specification of the output interval and for the currently specified output interval to begin to flash.	
⑥		Press the  key until the desired output interval has been selected. Pressing the  key here causes the menu item lit up to change from '30S' to '1M' to '2M' to '5M' to '10M' to 'FIN' and back to '30S' in sequence each time the  key is pressed. Note that here an interval of '1M' has been selected.	
⑦	  	When the desired output interval begins to flash, press the  key. The next step to be performed here differs depending on the output destination specified in step ④. Procedure performed if 'TBL' or 'PC' has been selected: The currently specified output destination will be displayed and the display will return to the state shown in step ②. If you wish to specify other menu settings, press the  key to select the desired menu item. If you wish to exit from specifying menu settings, press the  key. Procedure performed if 'GRP' has been selected: Control will shift to the specification of the range of measurement values described in step ⑧ and thereafter.	

Specifying the range of measurement values to be used (when 'GRP' has been selected)

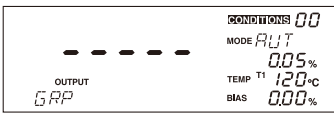













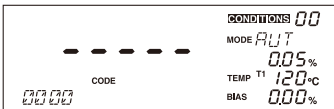

Step	Key(s) used	Operating instructions	Display
⑧		The currently selected minimum for the range of measurement values will begin to flash.	
⑨		Press the   keys to select the desired minimum value. Note that here a value of '5%' has been selected.	
⑩		When the desired minimum begins to flash, press the  key. This will cause the maximum for the range of measurement values to begin to flash.	
⑪		Press the   keys to select the desired maximum value. Note that here a value of '20%' has been selected.	
⑫	  	When the desired maximum begins to flash, press the  key. The currently specified output destination will be displayed and the display will return to the state shown in step ②. If you wish to specify other menu settings, press the  key to select the desired menu item. If you wish to exit from specifying menu settings, press the  key.	

10-2-3 Specifying sample codes

This section describes how to specify sample codes to be used when outputting measurements to a printer or computer. Sample codes may be specified as 4-character codes.

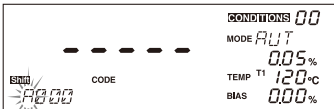
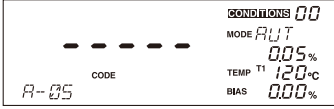
- Any digit from 0~9, and letter from A~Z, or a hyphen (i.e., '—') may be specified as the value of the first or second character of the code.
- Only digits from 0~9 may be specified as the value of the third or fourth character of the code.
- * The digits in the third and fourth characters of the code are automatically incremented after each measurement, with the value returning to '00' when it would otherwise exceed a value of '99'.
- * Press the  key to switch alphabetic and numeric input. When the 'Shift' mark is displayed, alphabetical letter can be entered, if not, numerals can be entered.

■ How to specify sample codes















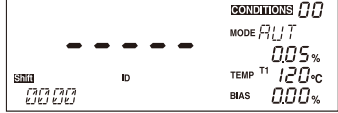

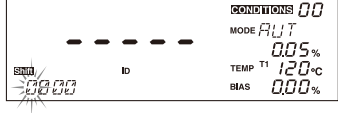

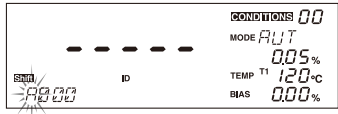
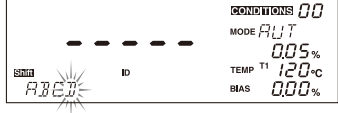
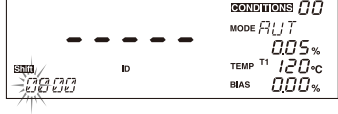

Step	Key(s) used	Operating instructions	Display
①		With the display displaying the weight in grams, press the  key.	
②		Press the  key until the 'CODE' menu item is displayed.	
③		Press the  key. The highlight will then shift to the specification of the sample code and the first character of the currently selected 'CODE' will begin to flash.	
④	 → 	Press the  →  keys to select a digit from 0 to 9, a letter from A to Z or a hyphen. Note that here 'A' has been selected.	
⑤		Repeat step ④ until the fourth character has been specified.	
⑥		The sample code just specified will then be displayed and the display will return to the state described in step ②.	
⑦	 	If you wish to specify other measuring conditions settings, press the  key to select the setting to be specified. To exit from specifying measuring conditions settings, press the  key instead.	

10-2-4 Specifying an ID (device ID)

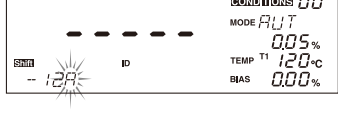
This section describes how to specify the device ID output when outputting data to a printer or computer. The device ID is an 8-character ID which may be set using the following characters: digits from 0~9, letters from A~Z, and hyphens (i.e., '—').

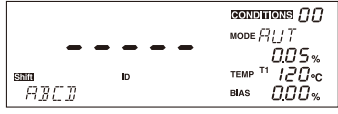
- * Press the **Shift** key to switch alphabetic and numeric input. When the 'Shift' mark is displayed, alphabetical letter can be entered, if not, numerals can be entered.















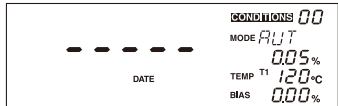

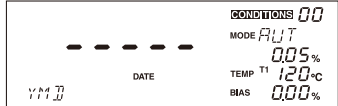



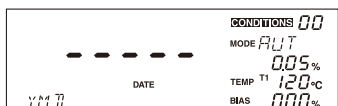



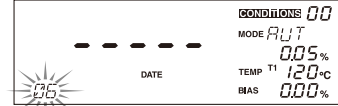



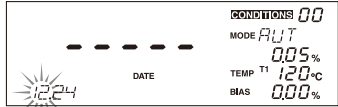



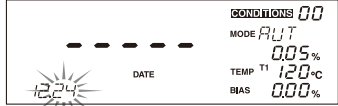



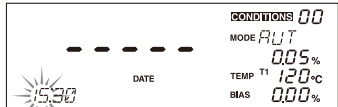

■ How to specify a device ID

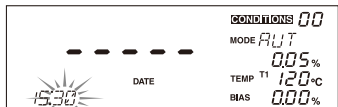
Step	Key(s) used	Operating instructions	Display
①		With the display displaying the weight in grams, press the  key.	
②		Press the  key until the 'ID' is displayed.	
③		Press the  key. The device ID numbers 1 to 4 will be displayed and the first digit of the device ID presently set will flash.	
④	 → 	Press the  →  keys to select the desired character (digit from 0 to 9, a letter from A to Z, or a hyphen). In this case, the letter 'A' has been selected.	
⑤		Repeat step ④ until the fourth character has been specified.	
⑥		After setting to the fourth character has been completed, the fifth to the eighth character of the device ID will be displayed with the first character flashing.	
⑦	 → 	Just as with the first four characters, enter to the eighth character by pressing the  →  keys. In this case, a value of '-12A' has been specified.	
⑧		After setting to the eighth character has been completed, if the eighth character is an alphabetic character, press the  key.	
⑨		The device ID that is now set is displayed and it returns to state ②.	
⑩	 	If you wish to specify other measuring conditions settings, press the  key to select the setting to be specified. To exit from specifying measuring conditions settings, press the  key instead.	

10-2-5 Setting the date and time

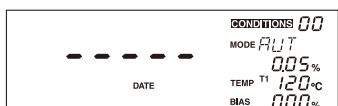
This section describes how to set the date and time. Note that while the internal clock is already set at the time of shipment, the following procedure should be used whenever resetting the clock. Also note that the date and time of measurement are output whenever measurement data is output to a printer or computer.

■ How to set the date

Step	Key(s) used	Operating instructions	Display
①		With the display displaying the weight in grams, press the  key.	
②		Press the  key until the 'DATE' menu item is displayed.	
③		Press the  key. This will cause the highlight to shift to the output DATE format and the currently selected output format to be displayed. * The output format will be displayed in the order 'YMD' (year, month, day, and time), 'MDY' (month, day, year, and time), and 'DMY' (day, month, year, and time).	
④		Press the  key until the desired output format is displayed. Each time the  key is pressed the display will change from 'YMD' to 'MDY' to 'DMY' and back to 'YMD' again. * Note that while we describe the procedure to be followed when specifying dates in 'YMD' format, the order in which settings are specified in steps ⑤ through ⑦ differ depending on the format selected.	
⑤		When the desired output format has been displayed, press the  key. This will cause the highlight to shift to the specification of the date and the 2-digit value for the currently specified year to begin to flash. Press the   keys to select the correct 2-digit year.	
⑥		Pressing the  key causes the specified year to be set and the highlight to shift to the specification of the 2-digit value for the current month. Press the   keys to select the correct 2-digit month.	
⑦		Pressing the  key causes the specified month to be set and the highlight to shift to the specification of the 2-digit value for the current day. Press the   keys to select the correct 2-digit day.	
⑧		Pressing the  key causes the specified day to be set and the highlight to shift to the specification of the 2-digit value for the hour portion of the current time. Press the   keys to select the correct 2-digit hour.	
⑨		Pressing the  key causes the specified hour to be set and the highlight to shift to the specification of the 2-digit value for the minutes portion of the current time. Press the   keys to select the correct 2-digit minutes setting.	
⑩		Pressing the  key causes the specified minutes selection to be set and only 'DATE' to be displayed. (The clock will start counting from 0 seconds the moment the  key is pressed.)	
⑪	 	If you wish to specify other measuring conditions settings, press the  key to select the setting to be specified. To exit from specifying measuring conditions settings, press the  key instead.	

10-2-6 CAL (Scale calibration)

10-2-6-1 Calibrating the scales

The scale is designed to allow it to be calibrated. Calibration is performed at two points: 0 and 100 grams. The FD-800 may also be connected to a printer to make it possible to automatically generate calibration records in compliance with GLP, GMP, and ISO standards. (For further information, see “● Printing calibration records when performing calibration” on p. 64.)

- * The power to the unit should be turned on at least 30 minutes before calibration is performed in order to ensure accurate calibration.
- * The FD-800 is extremely sensitive to interference from drafts, breezes, vibration, and other disturbances in the surrounding environment, and care should be taken to ensure that there is no such interference before performing calibration.
- * It is impossible to accurately calibrate the scale immediately after performing measurements or at any other time when the heater lid is hot. Allow the temperature of the heater lid to cool down to ambient temperature before performing calibration.
- * The weights used should consist of standard OIML weights or some other type of non-magnetic weights.
- * When placing a weight on the sample dish, it should be placed so that the center of gravity of the weight is near the center of the dish.
- * The heater lid must be closed during calibration to prevent a calibration from being affected by drafts or breezes, and the height of the weights used should be such that they do not come into contact with the temperature sensor or heater.
- * If you wish to abort a calibration already in progress, press the Tare/Reset key. An 'Abort' message will be displayed and the screen will return to a weight display.

■ Scale calibration procedure

Step	Key(s) used	Operating instructions	Display
①	Menu	With the display displaying the weight in grams, press the Menu key.	
②	Select	Press the Select key until the 'CAL' menu item is displayed.	
③	Enter	Press the Enter key. When the temperature control switching display is T2, 'BAL' is flashing. When the temperature control switching display is T1, proceed to ④.	
④	Enter	Press the Enter key. This will cause the calibration settings to be displayed and the setting '100.000' to begin to flash.	
⑤	Select Enter	To change the 100-gram weight value used here, press the Select key. This will cause the displayed value to stop flashing. Next, press the 0 g keys to enter a value for the weight. Pressing the Enter key then causes the specified weight value to begin flashing.	
⑥	Enter	Open the heater lid and place a weight of the specified weight inside. Closing the heater lid and pressing the Enter key causes a string of hyphens (i.e., '- - -') to be displayed, 100-gram calibration to come to an end, and then a flashing value of '0.000' to be displayed.	

Step	Key(s) used	Operating instructions	Display
⑦		<p>With the value '0.000' flashing, open the heater lid and remove the weight.</p> <p>Closing the heater lid and pressing the key causes a string of hyphens (i.e., '- - - -') to be displayed, 0-point calibration to come to an end, and then an 'END' message to be displayed.</p> <p>* If the unit is connected to a printer, then a calibration record will be automatically printed out.</p>	
⑧		After several seconds, the display will return to the regular weight display.	

10-2-6-2 Calibrating the radiation thermometer (T2)

The radiation thermometer is calibrated at two points at ambient temperature and at optional temperature between 100°C and 180°C. Place the heating reference material at the stipulated location so it is in contact with the digital thermometer. And it is possible to automatically keep a calibration record compatible with GLP, GMP, and ISO by connecting a printer. (For further information, see “● Printing calibration record during CAL (radiation thermometer calibration)” on p. 64.)

- * An optional radiation thermometer calibration kit (digital thermometer, heating reference material) is necessary for the calibration.
- * In order to perform an accurate calibration, turn on the electric power more than 30 minutes before the calibration and set the heating reference material inside the device so it is sufficiently acclimatized to room temperature.
- * For the method of using the radiation thermometer calibration kit, see the Users Manual for the Radiation Thermometer Calibration Kit.
- * If you wish to abort a calibration already in progress, press the key. An 'Abort' message will be displayed and the screen will return to a weight display.

■ Radiation thermometer calibration procedure

Step	Key(s) used	Operating instructions	Display
①		Confirm that the temperature control switch display is set to T2, then press the key in temperature and weight display status. (If the thermometer control switch display is T1, it will not begin radiation thermometer calibration.) The way of switching to T2 (see "TEMP (drying temperature)" on p. 34).	
②		Press the key until the 'CAL' menu item is displayed.	
③	 	Press the key, and then 'BAL' flashes. Press the key until 'TEMP' flashes.	
④		Press the key. [OO C] (room temperature of OO°C at the moment the key is pressed.) flashes.	
⑤	→ 9	Select the temperature (rounded of below the decimal point) that was displayed on the thermometer attached to the heating reference material with the → 9. Here, 21°C is selected.	
⑥	 → 9	If you press the key, the calibration temperature flashes. To change the calibration temperature, press the → 9.	

Step	Key(s) used	Operating instructions	Display
⑦		After the calibration temperature has been selected, press the key. The heater turns on and heats until the calibration temperature.	
⑧	→	After the heater turns on, the buzzer sounds after 10 seconds and the calibration temperature flashes, so select the temperature (rounded of below the decimal point) that was displayed on the thermometer attached to the heating sample with the → . Here, 162°C is selected.	
⑨		If the key is pressed after the heating reference material temperature has been selected, the calibration stops and 'End' is displayed. * If a printer is connected, the calibration record is automatically printed out.	
⑩		After a short interval, it returns to the normal weight display state.	

10-2-7 Specifying a password









In order to prevent the specified measuring conditions from being modified unexpectedly, a password may be specified to prevent other users from changing the specified conditions. The password is 4 characters in length and may be set using the following characters: digits from 0~9, letters from A~Z, and hyphens (i.e., '—').

If the password has been set to any password other than the default password of '0000' set at the time of shipment, whenever the key is pressed to specify measuring conditions the indicator 'PASS' is displayed in the weight display area and the user is required to enter a password.

■ How to specify a password

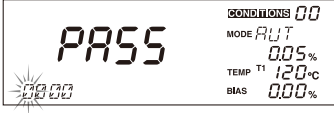
Step	Key(s) used	Operating instructions	Display
①	 	From the weight display, press the key and hold the key down while pressing the key.	
②		The default password of '0000' will be displayed with the first character of the password flashing. The indicator 'SET' will be displayed in the weight display area.	
③	→	Press the → keys to select the desired character (i.e., a digit from 0~9, a letter from A~Z, or a hyphen). Note that here the letter '1' has been selected.	
④		Repeat to step ③ until the fourth character has been specified. Note that here a value of '1234' has been specified.	
⑤		When the fourth character has been specified, press the key. This will complete the setting of the password, and the display will return to the standard weight display.	











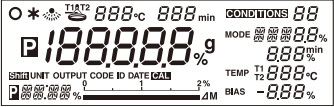

[Changing/canceling the password]

Step	Key(s) used	Operating instructions	Display
⑥	 	<p>To change or cancel the specified password, press the  key while pressing the  key in the weight display state. PASS is displayed in the weight display, and the first character of '0000' flashes, so the operation is repeated to ③ to select the previously specified password.</p> <ul style="list-style-type: none"> * If the selected password is different from the specified password, the buzzer sounds for 1 second and FAIL is displayed, then it returns to weight display status. * When the specified password is missing, see “forced cancellation of password” on the attachment. 	
⑦		<p>After the four digit password has been completely entered, press the  key. 'SEt' is displayed on the weight display. '0000' is displayed and the first character flashes, so specify a new password in the same way as steps ③ and ④. When the password is cancelled, select '0000'.</p>	

10-2-8 Specifying the power settings

This subsection describes the procedure to be followed in specifying the power settings to be used in accordance with the type of power being used. Note that the voltages which may be specified differ depending on the power setting selected using the power conversion switch. Note that this setting must be specified when using the FD-800 in countries outside of Japan or whenever there is a change in the type of power source being used.

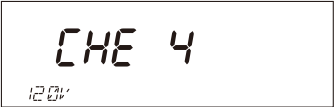
■ How to specify the power settings

Step	Key(s) used	Operating instructions	Display
①	 Turn on power	Turn on the power while holding the  key pressed down. * Note that you should not remove your finger from the  key until a string of hyphens (i.e., '- - - -') are displayed.	
②		A tone will sound, the display will light up with all items lit and then change to display first 'CHE5' and then a string of hyphens (i.e., '- - - -'). At the bottom left of the display will be displayed the currently specified power settings.	  
③		If the power conversion switch has been set to '100~120V', then pressing the  key will cause the display to switch from 100V to 110V to 120V and back to 100V in sequence. If the power conversion switch has been set to '220~240V', then pressing the  key will similarly cause the display to switch from 220V to 230V to 240V and back to 220V in sequence. Note that here a voltage level of '120V' has been specified.	
④		When the desired voltage is displayed, press the  key. The display will then change from 'CHE4' to 'CHE0' in sequence with the specified voltage still displayed.	 ⋮ ⋮ ⋮
⑤		A tone will then sound and the display will return to the regular weight display.	

11. Error Messages

If any of the following error messages are displayed, follow the procedures described below to check for the cause of the error and take appropriate action to remove the error.

If the error cannot be removed by following the procedures described below, then you should contact the vendor from which you purchased the unit or the Kett Tokyo sales office or a local Kett office or sales office for assistance.

Message	Description	Action to be taken
ER102	The scale stopper located below the sample dish panel has not been removed.	Remove the scale stopper located under the sample dish panel. (See item ③ in “6. Assembly and Installation of Main Unit” on p. 14 for instructions.)
ER103	The sample is too light (i.e., under 0.1 grams).	The minimum sample weight which can be used with this product is a weight of 0.1 grams. Try measuring again using a sample of at least 0.1 grams in weight. Press the Tare/Reset key to make the error message disappear.
ER104	The sample is too heavy (i.e., over 120 grams).	The maximum sample weight which can be used with this product is a weight of 120 grams. Try measuring again using a sample of less than 120 grams in weight. Press the Tare/Reset key to make the error message disappear.
ER201	Invalid moisture content value (Occurs when weight increases by more than 0.1 grams)	This error is displayed when a sample is added during measurement. Press the Tare/Reset key to make the error message disappear.
ER202	Invalid moisture content value (Occurs when weight being measured is less than -1 grams)	Press the Tare/Reset key to make the error message disappear.
ER306	Heater lid open	Press the Tare/Reset key to make the error message disappear.
ER401	Internal weight measuring unit communications error	Turn off the power and then turn the power back on again.
ER501	Invalid weight used during scale calibration	Use a calibration weight of the correct weight. Press the Tare/Reset key to make the error message disappear.
ER502	Instability encountered during scale calibration	Perform calibration again with the unit placed on a flat, stable surface not subject to the effects of external vibration, drafts, or breezes. Press the Tare/Reset key to make the error message disappear.
ER701	Power source voltage abnormal	Turn the power to the unit off, check to make sure that the power conversion switch located on the back of the unit is set to the correct position, and then turn the power back on again.

If any of the following errors are displayed, it indicates that a failure or breakdown of internal parts or components has occurred. Contact the vendor from which you purchased the unit or the Kett Tokyo sales office or a local Kett office or sales office for assistance.

Message	Source of problem
ER301	Thermistor (T1) short circuit
ER302	Thermistor (T1) disconnected
 ER303	Heater overheated This error indicates the existence of an extremely hazardous condition. Turn the power off immediately and without delay contact a Kett representative for assistance.
ER304	Temperature measurement error
ER305	Heater failure
ER307	Radiation thermometer (T2) disconnected
ER308	Radiation thermometer (T2) internal error
ER601	Auto-taring mechanism error
ER602	
ER603	
ER702	Power failure
ER801	Memory error
ER802	Internal clock error

12. Concerning the radiation thermometer

The FD-800 is an infrared moisture analyzer that can measure and control temperature in two ways: temperature measurement by a conventional thermistor (T1) and temperature measurement by a radiation thermometer (T2) that has been newly installed. Temperature measurement by a thermistor mainly measures the ambient temperature inside the heating chamber, but a radiation thermometer is intended to measure the surface temperature of the sample.

12-1 Radiation thermometer

An entire specimen radiates infrared rays, The strength of the infrared rays that it radiates increases as the temperature rises. The temperature based on the radiation thermometer is obtained by using an infrared sensor to measure the infrared radiant energy emitted from the surface of the tested sample then converting this radiant energy into temperature. So it can measure the surface temperature of a sample without contacting it.

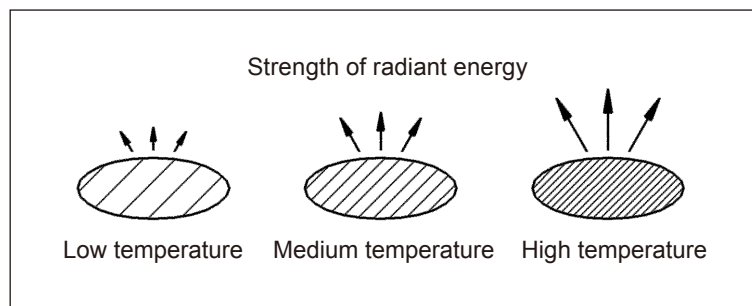

12-2 Emissivity

To explain emissivity, there is the concept of the **black body**. A black body is an imaginary ideal object that reflects all infrared rays from its surface without including any reflection or penetration elements.

But actual objects have reflection and penetration elements according to their materials and surface shape (high and low parts).

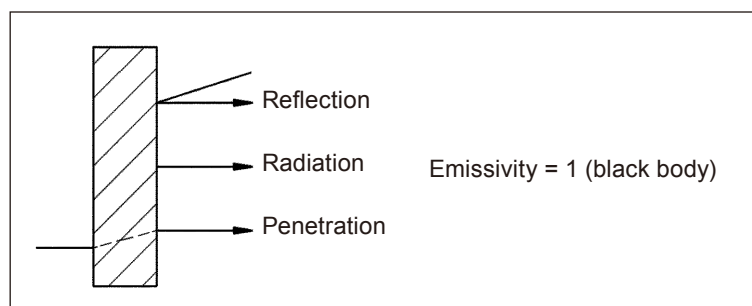

Emissivity is normally represented by (ϵ): the ratio of the ideal total radiant energy with a black body as the standard (E) and the energy emitted by an actual object (E').

Emissivity (ϵ) = energy radiated by an actual object (E') / total radiated energy (E)

The emissivity establishes the equation, “**emissivity + reflectivity + permeability = 1**” based on physical measurement.

The following is the emissivity example.

* **The following table is an example. The emissivity differs according to the material qualities, so that even on the same object, it differs according to surface shape and thickness.**

Material	Emissivity	Material	Emissivity
Asphalt	0.9 – 0.98	Tanned skin	0.75 – 0.80
Concrete	0.94	Charcoal (powdered)	0.96
Cement	0.96	Lacquer coating	0.80 – 0.95
Sand	0.90	Lacquer coating (black)	0.97
Soil	0.92 – 0.96	Lacquer coating (white)	0.8 – 0.95
Water	0.92 – 0.96	Rubber (black)	0.94
Glass	0.90 – 0.95	Plastic	0.85 – 0.95
Ceramic	0.90 – 0.94	Wood	0.90
Marble	0.94	Paper	0.70 – 0.94
Fluorspar	0.30 – 0.40	Aluminum (before oxidation)	0.03 – 0.15
Plaster	0.80 – 0.90	Aluminum (after oxidation)	0.8 – 0.95
Mortar	0.89 – 0.91	Copper (before oxidation)	0.03 – 0.15
Red brick	0.93 – 0.95	Copper (after oxidation)	0.4 – 0.8
Fiber	0.90	Steel (before oxidation)	0.05 – 0.15
Cloth (black)	0.98	Steel (after oxidation)	0.8 – 0.95
Skin (human)	0.98	Stainless steel	0.45

To measure the temperature of a sample with a radiation thermometer, in principle, it is necessary to preset the emissivity suited to the sample as shown on the table, but as shown by the table, even when the sample is specified, there is a range of the emissivity and it is extremely difficult to determine a single value in an actual case.

But the infrared moisture content gauge was originally intended to obtain water content: not to obtain an accurate absolute temperature. Even if there is a considerable gap between the specified temperature and the actual sample temperature, if there are no problems with reproducibility of the measured temperature nor with differences between instruments and a value equal to the official value can be obtained, this temperature may be registered as a measurement condition so it can be used as a water content gauge without any problems.

Fortunately, almost all samples that are measured by an infrared water content gauge (food, grain, cosmetics, pastes, etc.) have high emissivity of 0.9 or more, and their scattering is small, so that even if their individual emissivity is not specified, no large temperature errors occur and they can be measured with good reproducibility.

This is not unrelated to the fact that it is the infrared water content gauge that takes advantage of the principle that when a sample is dried, the sample absorbs the infrared rays. The fact that absorptivity of infrared rays conforms with emissivity is known as a physical law (Kirchhoff's Law).

For such reasons, the emissivity of the FD-800 is set at the fixed value of **0.95**.

12-3 Radiation thermometer temperature measurement spot

Radiation thermometer temperature measurement spot (temperature detection area) is as shown in the following figure.

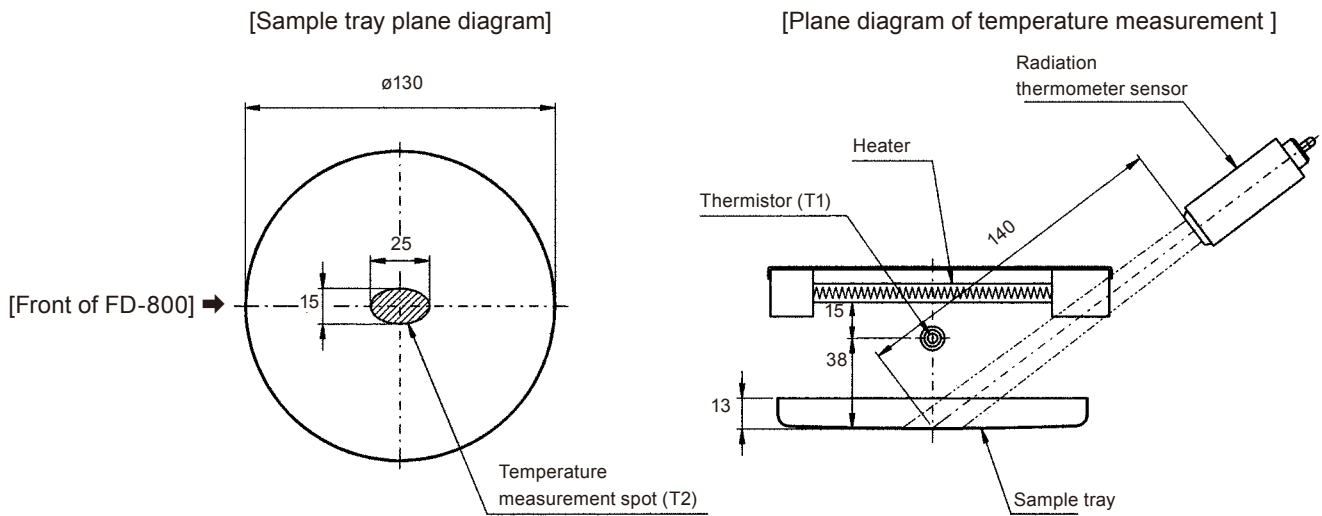

- * When the sample is placed on a sample tray, be sure to measure it inside this spot (the sample horizontally embedded). If part of the sample tray is visible inside the spot, the temperature of the sample tray (stainless steel) is detected, causing temperature measurement errors. (A stainless steel tray has low emissivity, so its detected temperature is low.)
- * If part of the sample tray is unavoidably visible inside the spot because of the shape and state of the sample, (dried noodles or fibrous materials etc.), lay down the attached glass fiber sheet to make the measurement with the sample tray invisible.

12-4 Relationship of T1 and T2

The values of T1 and T2 vary during heating, and the following is their rough relationship. The set temperature of the infrared water content gauge FD-720 corresponds to T1 here.

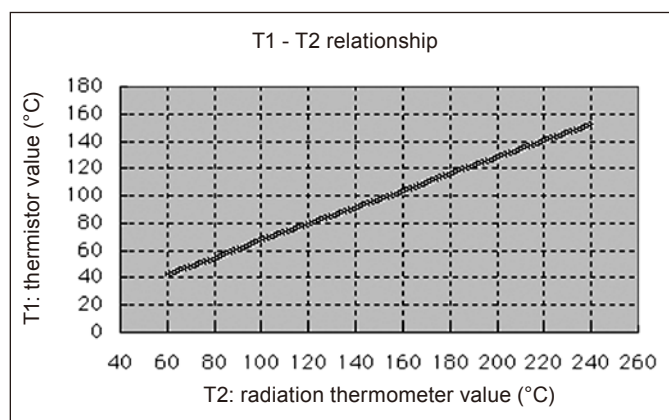

- * This relationship is for a case where the T2 temperature is the “Heating standard sample*¹” surface temperature. Measurement of actual samples include cases where this relationship differs according to the type and state of the sample. Use this only as a yardstick.

*¹ These are the parts of the optional Radiation Thermometer Calibration Kit.

12-5 Radiation Thermometer Calibration Kit

The FD-800 is calibrated before it is shipped so that its radiation thermometer displays the correct temperature, so use it as it is when it was delivered. But in a case where it is necessary to confirm the precision of the radiation thermometer and differences between instruments for control purposes, the radiation thermometer calibration kit has been provided as a device to be used to calibrate the radiation thermometer (option).

- * **Calibration method (see "10-2-6-2 Calibrating the radiation thermometer" on p.45)**
- * **For the method of operating the radiation thermometer calibration kit, read the Users Manual for the radiation thermometer calibration kit.**

13. Predictive Measurements

13-1 A Description of Predictive Measuring

Infrared moisture content testers can be used to measure the moisture content of a wide range of different materials, thus making it possible to measure the moisture content of almost anything. This is the most important feature found in infrared testers not found in other types of testers. At the same time, however, because an infrared moisture content tester operates by heating samples to evaporate the moisture content, it takes a fair amount of time to obtain measurements. In order to make it possible to shorten the amount of time required for taking measurements and to provide a means of approximating the moisture content measurements which would be obtained using standard methods, predictive measuring mode has been developed.

In predictive measuring mode,

- ① An estimate is calculated of the final moisture content while drying is still in progress.
- ② It is necessary to specify three settings before measuring: the drying temperature, the predicted value convergence range, and the bias.
- ③ This mode is designed for use only with materials which display a drying curve of the type generally referred to as an 'S curve'.^{*1}

^{*1} When compared to other curves showing the degree of drying which takes place when the moisture content of a given material changes as drying progresses, an 'S-curve' is a curve in which the degree of change in moisture content (i.e., ΔM) in the initial stages of drying is low and then increases towards the middle of the drying process and then decreases progressively as the drying process nears completion.

● Drying temperature

Since the desired value is that which would be obtained when operating in automatic halting mode, the drying temperature specified should be the same as that which would be specified in automatic halting mode.

● Predicted value convergence range

When operating in predictive operating mode, predicted values are internally calculated every 30 seconds, and while variation occurs in the calculated values, the degree of variation grows smaller as more and more time elapses. The FD-800 has been designed to treat the final predicted value as having been obtained when the range of variation falls within the predicted value convergence range. The range of allowable variation in predicted final moisture content is referred to as the predicted value convergence range.

The predicted value convergence range may be specified as a percentage anywhere from 0.1 to 9.9 percent. While specifying a higher value for the predicted value convergence range causes the final predicted value to be calculated more quickly, the specification of a higher value may also result in greater degrees of error occurring in predicted values. Conversely, while it is possible to obtain more stable sets of predicted values when a lower value is specified for the predicted value convergence range, specifying lower values tends to make it take significantly longer to calculate a final predicted value. The value specified for the predicted value convergence range should accordingly be specified according to your objectives. Note that the default setting for the FD-800 is a value of 0.5 percent.

● Bias

Bias is used to change the average lower limit of fixed values with respect to predicted measurement values. On the FD-800, a bias of anywhere from -9.99 to $+9.99$ percent may be specified. When performing a comparative measurement, the FD-800 automatically requests a bias to be used to correct measurements to match those obtained in automatic halting mode.

● Comparative measuring mode

In comparative measuring mode, predicted measurements are displayed while measuring is in progress and measuring is halted under the same conditions as when operating in automatic halting mode. The difference between the measured value and predicted value is displayed as the bias.

In order to obtain more accurate predicted measurements, it is recommended that when calculating the bias you should perform at least 5 comparative measurements and take the average of all measurements obtained to use as the bias.

You should also take care in terms of the amount of material and the way the sample material is placed onto the sample dish to ensure that the sample material is laid out as evenly as possible and sample amounts are similar.

Note that no predicted measurement or bias can be calculated if a predicted measurement is not obtained before the measurement is completed.

● Predictive measuring mode

It is possible to obtain actual predicted measurements by specifying the same drying temperature, predicted value convergence range, and bias as calculated when performing comparative measurements in comparative measuring mode.

Note that measuring is halted if no predicted measurement has been calculated after 30 minutes have elapsed since the time when the measurement was begun.

13-2 Procedure for Obtaining Predicted Measurements



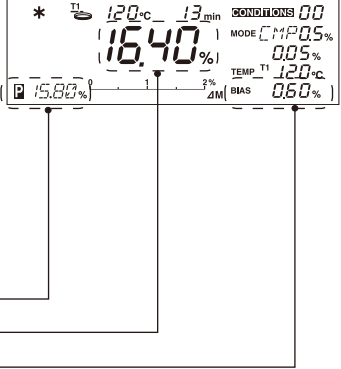

- 1) Use the comparative measuring mode to calculate the bias to be specified to obtain the predicted measurement. (See “13-2-1 Calculating the bias to be specified when operating in predictive measurement mode” on p. 57 for instructions on how to do so.)
- 2) Use the bias calculated in comparative measuring mode in step 1) to specify the bias, perform the measurement, and evaluate the predicted measurement. (See “13-2-2 Evaluating predicted measurements” on p. 59 for instructions on how to do so.)
- 3) Measure in predictive measuring mode. (See “13-2-3 Obtaining predicted measurements” on p. 60 for instructions on how to do so.)

13-2-1 Calculating the bias to be specified when operating in predictive measurement mode



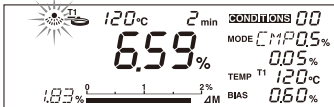

Step	Operating instructions	Display
①	Set the mode to comparative measuring mode. (See 9-2-2 “6) Specifying settings for COMPARE (Comparative measuring) mode” on p. 32 for instructions on how to do so.)	
②	Specify the desired predicted value convergence range. In the example shown here, a range of 0.5% is specified. * Note that the predicted value convergence range specified affects the amount of time required for measurement and the accuracy of predicted measurements, and that you should specify a range according to your objectives. (For further information, see “● Predicted value convergence range” on p. 55.)	
③	Specify the automatic halting conditions to be used (e.g., 0.05%).	
④	Specify the drying temperature to be used. (For further information, see “9-2-3 TEMP (Drying temperature)” on p. 34.) In the example shown here, a temperature of 120°C is specified.	
⑤	Set the bias to 0.00%. (See “9-2-4 Bias” on p. 35 for further information.)	
⑥	Place the sample onto the sample dish and begin measurement. (In the example shown here, the initial weight is 10.478 grams.)	
⑦	When the final predicted value has been calculated, it will be displayed. (In the example shown here, the measuring time was 7 minutes and the predicted measurement is 15.8 percent.)	

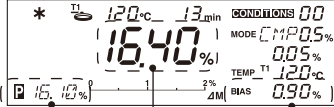
Step	Operating instructions	Display
<p>⑧</p>	<p>Completion of measurement Measuring will be completed when the conditions specified for automatic halting mode have been met. When measuring is completed, the bias will be displayed in the bias display area.</p> <p>* If no predicted measurement is displayed even after 30 minutes has elapsed from the time when measuring was initiated, it is probable that it is impossible to obtain a predicted measurement.</p> <p>[Measurement results]</p> <p>Predicted measurement _____</p> <p>Automatic halting mode measurement _____</p> <p>Bias + 0.60 = 16.40 (Automatic halting mode value) – 15.80 (Predicted measurement)</p>	
<p>⑨</p>	<p>Without changing any of the conditions used in steps ① through ⑤, repeat steps ⑥ through ⑧ to measure again 5 times or more and calculate the average bias.</p> <p>The average bias may then be used to specify the bias to be used in predictive measuring mode.</p> <p>* If the bias varies greatly from one time to the next when performing repeated measurements, then it is probably safe to assume that a predicted measurement cannot be obtained. If this happens you should measure in automatic halting mode or in some other mode instead of predictive.</p>	
<p>⑩</p>	<p>If you wish to use the calculated bias to evaluate predicted measurements, follow the procedure described in “13-2-2 Evaluating predicted measurements” on p. 59; if you wish to use the calculated bias to actually obtain predicted measurements, follow the procedure described in “13-2-3 Obtaining predicted measurements” on p. 60.</p>	

13-2-2 Evaluating predicted measurements

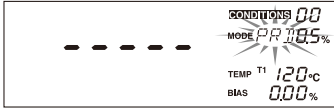
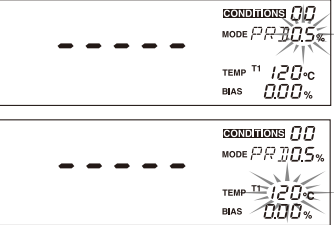
Step	Operating instructions	Display
①	<p>With the mode set to comparative measuring mode, specify the bias calculated following the procedure described in 13-2-1. In the example shown here, a bias of 0.60 percent has been specified. (For information on the bias, see “9-2-4 Bias” on p. 35.)</p> <p>* Do not change any other settings (i.e., the predicted value convergence range and drying temperature) at this time.</p>	
②	<p>Place the sample onto the sample dish and begin measurement. (In the example shown here, the initial weight is 10.478 grams.)</p>	 
③	<p>When the final predicted measurement has been obtained, a predicted measurement adjusted by the specified bias (here a bias of 0.60%) will be displayed. (In the example shown here, the measuring time was 7 minutes and the predicted measurement is 16.10 percent.)</p>	
④	<p>Completion of measurement Measuring will be completed when the conditions specified for automatic halting mode have been met.</p> <p>Measurement results</p> <p>Predicted measurement corrected by the specified level of bias (0.60%) = 15.50 (Predicted measurement when a bias of 0% is specified) + 0.60 (specified level of bias)</p> <p>Automatic halting mode measurement</p> <p>Bias + 0.90 = 16.40 (Automatic halting mode value) – 15.50 (Predicted measurement when bias is '0').</p> <p>* Note that the specified bias (0.60%) does not affect the bias displayed here.</p>	
⑤	<p>Without changing any of the specified in step ①, repeat steps ② through ④ to measure again 5 times or more and obtain a comparison of the values obtained when operation in automatic halting mode and predictive measurement mode.</p> <p>If the difference between the two sets of values is within an allowable range, then the specified bias may be judged to have been an appropriate one. If the difference between the two sets of values exceeds allowable levels, then the average bias from the comparison just performed should be calculated, the average then specified as the new bias setting, and the evaluation process performed again.</p> <p>* If the difference between the two sets of values exceeds allowable levels and the bias varies sharply over repeated measurements, then it is probably safe to assume that a predicted measurement cannot be obtained. If this happens you should measure in automatic halting mode or in some other mode.</p>	

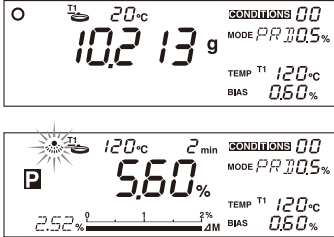
13-2-3 Obtaining predicted measurements

Step	Operating instructions	Display
①	Set the mode to predictive measuring mode. (9-2-2 “7) Specifying settings for PREDICT (Predictive measuring) mode” on p. 33 for instructions.)	
②	Specify the same settings for the predicted value convergence range and drying temperature as those used in comparative measuring mode (subsections 13-2-1 and 13-2-2). Example: Predicted value convergence range: 0.5% Drying temperature: 120°C	
③	Use the bias calculated following the procedures described in 13-2-1 and 13-2-2 to specify the bias (shown here as 0.60%). (Also see “9-2-4 Bias” on p. 35.)	
④	Place the sample onto the sample dish and begin measurement. (In the example shown here, the initial weight is 10.213 grams.) ⋮	
⑤	Completion of measurement The predicted measurement will then be displayed.	

14. Printing Output to a Printer (Option)

The FD-800 may be connected to a printer to make it possible to output measurement data or other information to the printer. Output which may be generated includes data consisting of intermediate or final measurements, sample codes, and measurement times.

* A dot-matrix printer may also be used, although it is impossible to obtain graphical output when using a dot-matrix printer. Please inquire with Kett if you require further information.

14-1 Sample Printer Output

● Output consisting solely of final values from multiple measurements

[Tabular output (TBL)]

<pre> KETT ELECTRIC LABORATORY Model : FD-800 S/N : AG60000 ID : KETT0001 Date : 2022.03.08 Condition : 00 Unit : Wet Base Moist. Temp. mode : T2 Mode : Auto Setting Temp. : 120C Auto Stop Cond. : 0.05% Bias : 0.00% Code Time Wet-Mass Dry-Mass Moist.(%) A-00 13:03 5.0245 4.4140 12.15 A-01 13:31 5.5402 5.3269 3.85 A-02 14:02 5.1942 4.7745 8.08 A-03 14:33 4.8514 3.9481 18.62 A-04 15:00 5.2647 4.9093 6.75 A-05 15:29 4.7414 4.0335 14.93 A-06 16:00 5.3815 5.3465 0.65 Signature : </pre>	<pre> Supplier : KETT ELECTRIC LABORATORY Model : FD-800 Serial number : AG60000 Device ID : KETT0001 Time of measurement : 2022/03/08 Measuring conditions storage area : 00 Measurement standard : Humidity standard water content Temperature control mode : T2 (radiation thermometer) Measurement mode : Automatic halting mode Drying temperature : 120°C Automatic halting conditions : 0.05% Bias : 0.00% </pre>
<pre> Code Time Wet-Mass Dry-Mass Moist.(%) A-00 13:03 5.0245 4.4140 12.15 A-01 13:31 5.5402 5.3269 3.85 A-02 14:02 5.1942 4.7745 8.08 A-03 14:33 4.8514 3.9481 18.62 A-04 15:00 5.2647 4.9093 6.75 A-05 15:29 4.7414 4.0335 14.93 A-06 16:00 5.3815 5.3465 0.65 </pre>	<pre> Sample code Time of measurement Pre-drying weight (g) Post-drying weight (g) Measured value (%) </pre>
<pre> Signature : </pre>	<p>Signature</p> <p>* Pressing the key after the completion of measurement cause the signature field to be printed.</p>

[Graph output (GRP)]

<pre> KETT ELECTRIC LABORATORY Model : FD-800 S/N : AG60000 ID : KETT0001 Date : 2022.03.08 Condition : 00 Unit : Wet Base Moist. Temp. mode : T2 Mode : Time Setting Temp. : 120C Drying Time : 10min. Bias : 0.00% Code Time Moist. (%) 0 4 8 12 16 20% B-01 10:02 19.54 -----* B-02 11:00 6.23 -----* B-03 11:59 15.41 -----* B-04 13:01 3.95 -----* B-05 14:02 14.12 -----* B-06 14:59 14.59 -----* </pre>	<pre> Supplier : KETT ELECTRIC LABORATORY Model : FD-800 Serial number : AG60000 Device ID : KETT0001 Time of measurement : 2022/03/08 Measuring conditions storage area : 00 Measurement standard : Humidity standard water content Temperature control mode : T2 (radiation thermometer) Measurement mode : Timed halting mode Drying temperature : 120°C Measurement time : 10 mins. Bias : 0.00% </pre>
<pre> Code Time Moist. (%) 0 4 8 12 16 20% B-01 10:02 19.54 -----* B-02 11:00 6.23 -----* B-03 11:59 15.41 -----* B-04 13:01 3.95 -----* B-05 14:02 14.12 -----* B-06 14:59 14.59 -----* </pre>	<pre> Sample code Time of measurement Measurement graph </pre>

● Output showing the intermediate values obtained during a single measurement

[Tabular output (TBL)]

KETT ELECTRIC LABORATORY	Supplier	: KETT ELECTRIC LABORATORY			
Model : FD-800	Model	: FD-800			
S/N : AG60000	Serial number	: AG60000			
ID : KETT0001	Device ID	: KETT0001			
Code : A-03	Sample code	: A-03			
Date/Time : 2022.03.08/16:07	Date & time of measurement	: 2022/03/08, 16:07			
Condition : 00	Measuring conditions storage area	: 00			
Unit : Wet Base Moist.	Measurement standard	: Humidity standard water content			
Temp. mode : T2	Temperature control mode	: T2 (radiation thermometer)			
Mode : Auto	Measurement mode	: Automatic measuring mode			
Setting Temp. : 190C	Drying temperature	: 190°C			
Auto Stop Cond. : 0.05%	Automatic halting conditions	: 0.05%			
Bias : 0.00%	Bias	: 0.00%			
Time (min)	T1 (C)	T2 (C)	Mass (g)	Moist. (%)	
0.0	33	35	7.2390	0.00	
0.5	61	87	7.2267	0.17	
1.0	138	170	7.1298	1.51	
1.5	164	191	6.9998	3.30	
2.0	150	189	6.8106	5.92	
2.5	140	190	6.6134	8.64	
3.0	133	190	6.4759	10.54	Elapsed measuring time
3.5	129	190	6.4127	11.41	Changes in drying temperature
4.0	126	190	6.3768	11.91	Changes in weight
4.5	124	190	6.3510	12.27	Measured value (%)
5.0	122	190	6.3325	12.52	
5.5	121	190	6.3191	12.71	
6.0	121	190	6.3083	12.86	
6.5	120	190	6.2999	12.97	
7.0	119	190	6.2931	13.07	
7.5	118	192	6.2870	13.15	
8.0	117	190	6.2822	13.22	
* 8.5	116	190	6.2782	13.27	

* Note on the decimal precision of printed weight data

Although the minimum weight which may be displayed by the FD-800 is 0.001 grams, weights (Mass) are printed to a precision of 4 decimal points because the values printed consist of averages from 7 measurements taken over each 30-second interval for each set of weight data output.

[Graph output (GRP)]

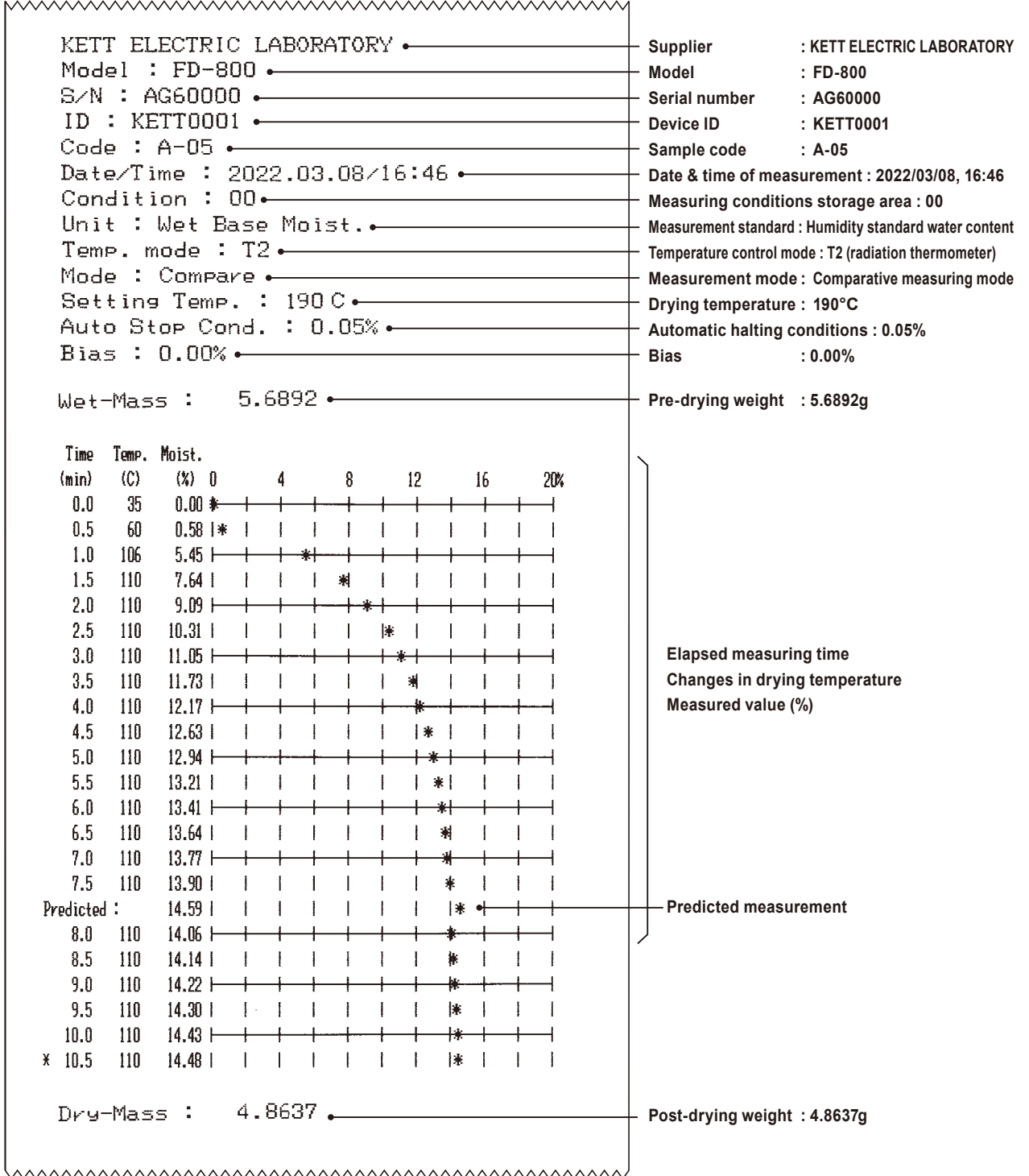

● **Printing calibration records when performing a calibration**

<p style="text-align: center;">WEIGHT CALIBRATION</p> <p>KETT ELECTRIC LABORATORY ●</p> <p>Model : FD-800 ●</p> <p>S/N : AG60000 ●</p> <p>ID : KETT0001 ●</p> <p>Date/Time : 2022.03.08/13:30 ●</p> <p>REF = 100.000g ●</p> <p>BFR = 99.999g ●</p> <p>AFT = 100.000g ●</p> <p>Signature : ●</p>	<p>Supplier : KETT ELECTRIC LABORATORY</p> <p>Model : FD-800</p> <p>Serial number : AG60000</p> <p>Device ID : KETT0001</p> <p>Time of measurement : 2022/03/08, 13:30</p> <p>Calibration use weight value: 100.000g</p> <p>Weight before calibration: 99.999g</p> <p>Weight after calibration: 100.000g</p> <p>Signature</p>
--	--

● **Printing calibration record during CAL (radiation thermometer calibration)**

<p style="text-align: center;">TEMPERATURE CALIBRATION</p> <p>KETT ELECTRIC LABORATORY ●</p> <p>Model : FD-800 ●</p> <p>S/N : AG60000 ●</p> <p>ID : KETT0001 ●</p> <p>Date/Time : 2022.03.08/14:37 ●</p> <p>Low Temp.</p> <p>REF = 26C ●</p> <p>BFR = 23C ●</p> <p>AFT = 26C ●</p> <p>High Temp</p> <p>REF = 165C ●</p> <p>BFR = 160C ●</p> <p>AFT = 165C ●</p> <p>Signature : ●</p>	<p>Supplier : KETT ELECTRIC LABORATORY</p> <p>Model : FD-800</p> <p>Serial number : AG60000</p> <p>Device ID : KETT0001</p> <p>Time of measurement : 2022/03/08, 14:37</p> <p>Heating standard sample temperature: 26°C</p> <p>Temperature before calibration: 23°C</p> <p>Temperature after calibration: 26°C</p> <p>Heating standard sample temperature: 165°C</p> <p>Temperature before calibration: 160°C</p> <p>Temperature after calibration: 165°C</p> <p>Signature</p>
--	--

14-2 Outputting Past Measurement Data

Record are stored of up to 100 past measurements in sequence from the most recent to the oldest. This data can be output to a printer or computer.

- ① Follow the directions given on p. 38 “10-2-2 Specifying the type and format of output” to set the output format to either ‘TBL’ or ‘PC’.
- ② From the weight display, press the **Start/Stop** key while pressing down the **Select** key.
- ③ The data will then be output (in order) beginning from the most recently measured data. To stop printing while printing is still in progress, press the **Start/Stop** key.

15. Computer Interface

The RS-232C interface may be used to connect the FD-800 to a computer with an RS-232C interface and output measurement data to that computer.

15-1 RS-232C Interface Specifications

Interface type : RS-232C
Communications method : Asynchronous communication
Baud rate : 2400 bps
Data bits : 8 bits
Parity : None
Stop bits : 1 bit
Connector : Female D-SUB9 pins
Pin layout :

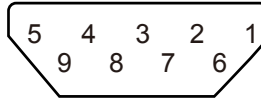

Pin number	Direction	Description
1		Not used
2	Output	TXD
3	Input	RXD
4		Not used
5		GND
6		Not used
7		Not used
8		Not used
9		Not used
Frame		Shield

15-2 Setting Up and Transmitting Data

15-2-1 Connecting the RS-232C cable

With the power to the FD-800 and the computer both turned off, connect the RS-232C cable. Insert the connector at the end of the RS-232C cable into the RS-232C port located at the rear of the FD-800 and then tighten the screws located at both sides of the cable connector. Follow the same procedure to insert the RS-232C cable into the RS-232C port of the computer. If the FD-800 has been moved, check to make sure that the FD-800 is level and, if not readjust until it is level. (See “6. Assembly and Installation of Main Unit” on p. 14 for instructions.)

15-2-2 FD-800 settings

Turn on the power to the FD-800 and set the measurement data output destination to ‘PC’. (See “10-2-2 Specifying the type and format of output” on p. 38 for instructions.)

15-2-3 Starting up the computer

Turn on the power to the computer and, when Windows has started, start the FD-800 Data Logger software FDL-02 or whatever software is to be used to read in data from the RS-232C interface.

- * **For instructions on how to use your computer, operating system (Microsoft Windows), or software being used, see the user manuals provided with your computer, operating system, or software.**
- * **The Microsoft Windows name and logo are the trademarks and registered trademarks of the Microsoft Corporation in the United States and other countries.**

15-3 Computer Output Format

Interface type	: RS232C
Numeric output format	: JIS (ASCII)
Delimiter code	: 0x09 (tab)
Delimiter	: 0x0D (CR) + 0x0A(LF)

■ Title output format at time of start of measurement

(Underscore characters (i.e., '_') are used below to indicate blanks (i.e., '20' in hexadecimal))

- ① "KETT_ELECTRIC_LABORATORY" + delimiter
- ② "_Model_:_FD800" + delimiter
- ③ "_SN:_:" + "XXXXXXX" (7-byte Serial No.) + delimiter
- ④ "_ID:_:" + "XXXXXXXX" (8-byte ID) + delimiter
- ⑤ "_Date/Time_:_:" + "XXXX" (4-byte year) + "." + "XX" (2-byte month) + "." + "XX" (2-byte day) + "/" + "XX" (2-byte hour) + ":" + "XX" (2-byte minutes) + delimiter
- ⑥ "_Condition_:_:" + "X" (2-byte conditions number) + delimiter
- ⑦ "_Unit:_:" + "Wet Base Moist." or "Dry Base Moist." or "Solid Content" + delimiter
- ⑧ "_Temp_Mode_:_:" + "T1" or "T2" + delimiter

- ⑨-1 Automatic halting format
"_Mode_:_Auto" + delimiter
"_Setting_Temp._:_:" + "XXX" (3-byte temperature setting) + "C" + delimiter
"_Auto_Stop_Cond._:_:" + "X.XX" (4-byte automatic halting conditions setting) + "%" + delimiter

- ⑨-2 Timed halting format
"_Mode_:_Time" + delimiter
"_Setting_Temp._:_:" + "XXX" (3-byte temperature setting) + "C" + delimiter
"_Drying_Time_:_:" + "XXX" (3-byte drying time setting) + "min." + delimiter

- ⑨-3 High-speed drying format
"_Mode_:_Rapid" + delimiter
"_Setting_Temp._:_:" + "XXX" (3-byte temperature setting) + "C" + delimiter
Automatic halting: "_Auto_Stop_Cond._:_:" + "X.XX" (4-byte automatic halting conditions setting) + "%" + delimiter
Timed halting: "_Drying Time_:_:" + "XXX" (3-byte drying time setting) + "min." + delimiter
"_Max_Temp._:_:" + "XXX" (3-byte of high-speed drying temperature) + "C" + delimiter
"_Delta M_:_:" + "X.X" (3-byte of degree of high-speed drying maintenance condition) + delimiter

- ⑨-4 Low-speed drying format
"_Mode_:_Slow" + delimiter
"_Setting_Temp._:_:" + "XXX" (3-byte temperature setting) + "C" + delimiter
Automatic halting: "_Auto_Stop_Cond._:_:" + "X.XX" (4-byte automatic halting conditions setting) + "%" + delimiter
Timed halting: "_Drying Time_:_:" + "XXX" (3-byte drying time setting) + "min." + delimiter

- ⑨-5 Stepped mode format
 “_Mode_: _Step” + delimiter
 tab + “Temp (C)” + tab + “Time (min.)” + delimiter
 The following output then appears the same number of times as the number of specified steps:
 “_Step” + “X” (1-byte step number) + tab + “XXX” (3-byte temperature setting) + tab + “XXX” (3-byte drying time setting) + delimiter
- ⑨-6 Comparative mode format
 “_Mode_: _Compare” + delimiter
 “_Setting_Temp._: _” + “XXX” (3-byte temperature setting) + “C” + delimiter
 “_Auto_Stop_Cond._: _” + “X.XX” (4-byte automatic halting conditions setting) + “%” + delimiter
 “_Pred. Tol._: _” + “X.X” (Predicted value convergence range) + delimiter
- ⑨-7 Predictive mode format
 “_Mode_: _Predict” + delimiter
 “_Setting_Temp._: _” + “XXX” (3-byte temperature setting) + “C” + delimiter
 “_Pred. Tol._: _” + “X.X” (Predicted value convergence range) + delimiter
- ⑩ “_Bias_: _” (+“-”) + “X.XX” + “%” + delimiter

■ Measurement output format

tab + “Time (min.)” + tab + “T1_(C)” + tab + “T2_(C)” + tab + “Mass (g)” + tab + “Moist (%)” + delimiter

■ Intermediate measurement output format

tab + “XXX.X” (5-byte measuring time) + tab + “XXX” (3-byte of thermistor temperature) + tab + “XXX” (3-byte of radiation thermometer temperature) + tab + “XXX.XXXX” (8-byte sample weight) + tab + Moisture content “XXX.XX” (6-byte moisture content) + delimiter

■ Final measurement output format

“*” + tab + “XXX.X” (5-byte measuring time) + tab + “XXX” (3-byte of thermistor temperature) + tab + “XXX” (3-byte of radiation thermometer temperature) + tab + “XXX.XXXX” (8-byte sample weight) + tab + Moisture content “XXX.XX” (6-byte moisture content) + delimiter

■ Sample output

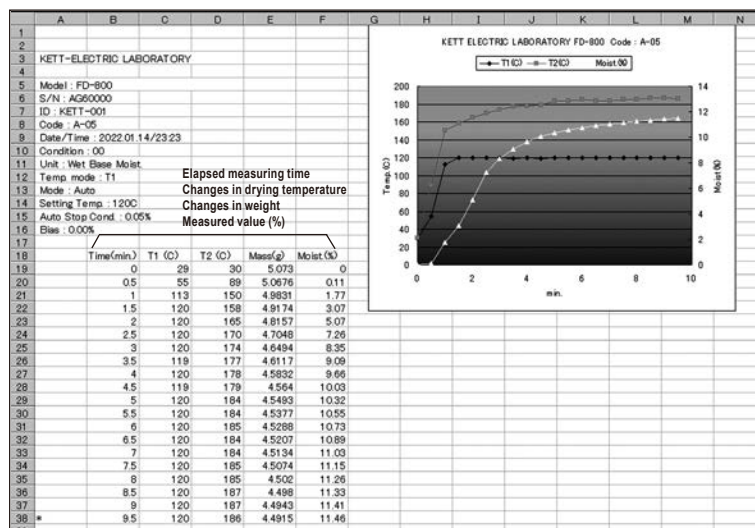

16. Maintenance

16-1 Performing Maintenance



Always be sure to remove the plug from its socket before performing maintenance.

① Removing parts and components

Remove the sample dish first, followed by the sample dish handler, sample dish tray, and wind shield in order. The radiation thermometer can be removed by pulling it out from behind after loosening the knurled screws (2) used for to anchor it by turning them 2 or 3 times. At this time, be careful that large force is not applied to the lead wire.

② Installing parts and components

See “6. Assembly and Installation of Main Unit” on p. 14 for instructions on how to install parts and components. Attach the radiation thermometer by reversing the removal procedure.

③ Remove any traces of spillage or soiling from samples.

④ Maintenance of the main unit

- Use a soft, dry cloth to wipe away any dirt or soil.
- Avoid applying strong pressure when wiping, even if you find dirt or soiling difficult to remove.
- If you find it particularly difficult to remove dirt or soiling, wet a cloth in water, or in water with a small amount of neutral detergent, wring the cloth thoroughly, and wipe. Next, rinse the cloth in water and wring it out to remove any detergent, and wipe again, then allow to dry.

⑤ Care of the lens on the radiation thermometer sensor

If the lens on the sensor is soiled, errors may occur. Clean the lens as instructed below.

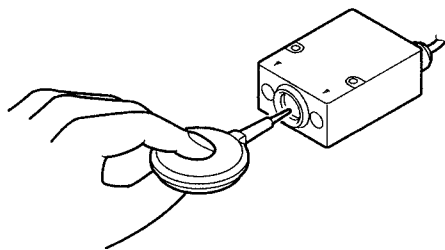

Remove dust from the lens using a blower made to clean camera lenses. Do not blow on it.

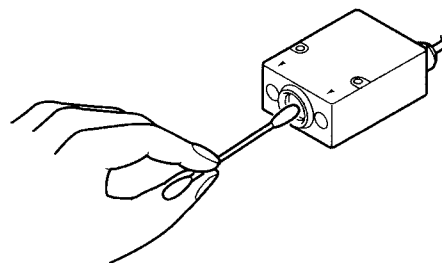

If it is extremely soiled, clean it gently with a cotton bud. If this does not remove the dirt, soak the cotton bud in alcohol first. Do not use any organic solvent other than alcohol.

⑥ Maintenance of parts and accessories

- Remove the spoon, spatula, sample dish, and wind shield from the main unit, and wash in water with a soft sponge.
- Reattach to the main unit and wait until completely dry before using the unit again.



* When using detergents, be sure to follow the instructions provided with the detergent in question.



* Never use paint thinner, benzene, or any volatile cleaning agents, or any abrasive cleansers or polishes.



* Never use wire brushes or other hard cleaning tools.

16-2 Replacing Fuses

- ① Remove the power cord from the unit.
 - ② The fuse holder is located at the rear of the unit. Insert a slot screwdriver or similar tool from the top of the fuse holder, and pull the fuse holder towards your body.
 - ③ Remove the fuses from the fuse holder and check to see if any are burned out.
 - ④ If there are no burned-out fuses, return the fuse holder to its original position. If there is a burned-out fuse, replace it with one of the spare fuses or with a compatible (T8A 250V) fuse.
 - ⑤ Return the fuse holder to its original position in the main unit.
 - ⑥ Insert the power cord back into the main unit.
- * If a fuse blows out again after being replaced, then there may be a problem with your unit, and you should have it checked and/or repaired.

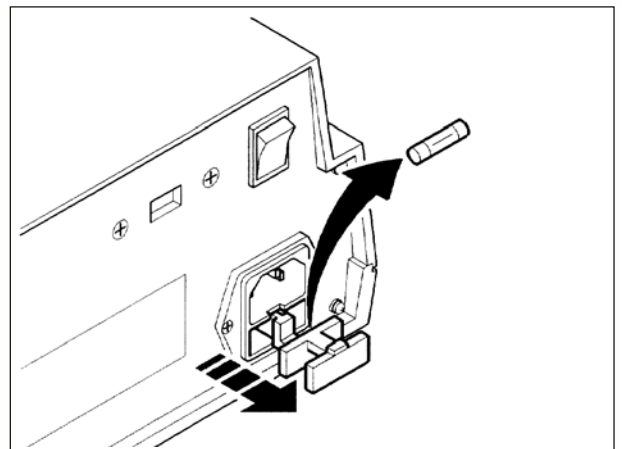
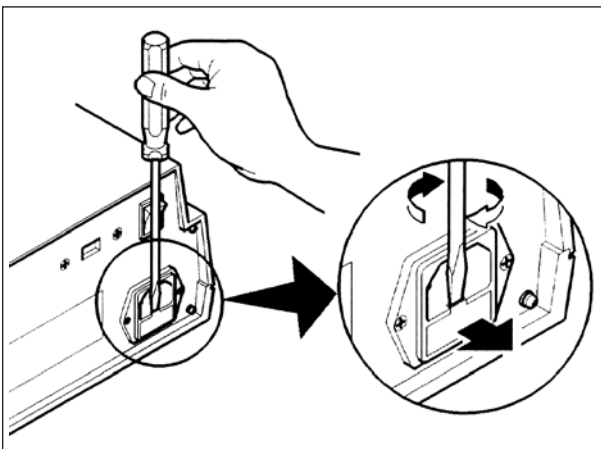

Notes

- Copying some or all of the contents of this user manual without prior written consent is strictly prohibited.
- The contents of this user manual may be changed at any time in the future without any prior notice.
- The appearance and/or representations of the products and parts depicted in this user manual may not appear exactly as their actual counterparts, but this does not affect their operation or functionality.
- This user manual was intended to be written as clearly and accurately as possible. However, if you are unclear about anything in this user manual or notice any missing information, please contact us directly.
- We cannot be held responsible for any actions or effects resulting from the execution of any operations outlined in this user manual.



KETT ELECTRIC LABORATORY

1-8-1 Minami-Magome Ota-Ku, Tokyo 143-8507 Japan
Tel. +81-3-3776-1121 Fax. +81-3-3772-3001
URL <http://www.kett.co.jp/> E-mail overseas@kett.co.jp